

## Masonry Design

---

### Notation:

<p><math>A</math> = name for area</p> <p><math>A_n</math> = net area, equal to the gross area subtracting any reinforcement</p> <p><math>A_{nv}</math> = net shear area of masonry</p> <p><math>A_s</math> = area of steel reinforcement in masonry design</p> <p><math>A_{st}</math> = area of steel reinforcement in masonry column design</p> <p><math>ACI</math> = American Concrete Institute</p> <p><math>ASCE</math> = American Society of Civil Engineers</p> <p><math>b</math> = width, often cross-sectional</p> <p><math>C</math> = name for a compression force</p> <p><math>C_m</math> = compression force in the masonry for masonry design</p> <p><math>CMU</math> = shorthand for concrete masonry unit</p> <p><math>d</math> = effective depth from the top of a reinforced masonry beam to the centroid of the tensile steel</p> <p><math>e</math> = eccentric distance of application of a force (<math>P</math>) from the centroid of a cross section</p> <p><math>f_a</math> = axial stress</p> <p><math>f_b</math> = bending stress</p> <p><math>f_m</math> = calculated compressive stress in masonry</p> <p><math>f'_m</math> = masonry design compressive stress</p> <p><math>f_s</math> = stress in the steel reinforcement for masonry design</p> <p><math>f_v</math> = shear stress</p> <p><math>F_a</math> = allowable axial stress</p> <p><math>F_b</math> = allowable bending stress</p> <p><math>F_s</math> = allowable tensile stress in reinforcement for masonry design</p> <p><math>F_t</math> = allowable tensile stress</p> <p><math>F_v</math> = allowable shear stress</p> <p><math>F_{vm}</math> = allowable shear stress of the masonry</p> <p><math>F_{vs}</math> = allowable shear stress of the shear reinforcement</p> <p><math>h</math> = name for height</p> <p style="padding-left: 20px;">= effective height of a wall or column</p> <p><math>I_x</math> = moment of inertia with respect to an x-axis</p>	<p><math>j</math> = multiplier by effective depth of masonry section for moment arm, jd</p> <p><math>k</math> = multiplier by effective depth of masonry section for neutral axis, kd</p> <p><math>L</math> = name for length or span length</p> <p><math>M</math> = internal bending moment</p> <p style="padding-left: 20px;">= type of masonry mortar</p> <p><math>M_m</math> = moment capacity of a reinforced masonry beam governed by steel stress</p> <p><math>M_s</math> = moment capacity of a reinforced masonry beam governed by masonry stress</p> <p><math>MSJC</math> = Masonry Structural Joint Council</p> <p><math>n</math> = modulus of elasticity transformation coefficient for steel to masonry</p> <p><math>n.a.</math> = shorthand for neutral axis (N.A.)</p> <p><math>N</math> = type of masonry mortar</p> <p><math>NCMA</math> = National Concrete Masonry Association</p> <p><math>O</math> = type of masonry mortar</p> <p><math>P</math> = name for axial force vector</p> <p><math>P_a</math> = allowable axial load in columns</p> <p><math>r</math> = radius of gyration</p> <p><math>S</math> = section modulus</p> <p style="padding-left: 20px;">= type of masonry mortar</p> <p><math>S_x</math> = section modulus with respect to an x-axis</p> <p><math>t</math> = name for thickness</p> <p><math>T</math> = name for a tension force</p> <p><math>T_s</math> = tension force in the steel reinforcement for masonry design</p> <p><math>TMS</math> = The Masonry Society</p> <p><math>w</math> = name for distributed load</p> <p><math>\beta_1</math> = coefficient for determining stress block height, <math>c</math>, in masonry LRFD design</p> <p><math>\epsilon_m</math> = strain in the masonry</p> <p><math>\epsilon_s</math> = strain in the steel</p> <p><math>\rho</math> = reinforcement ratio in masonry design</p>
--	--

---

## Reinforced Masonry Design

Structural design standards for reinforced masonry are established by the *Masonry Standards Joint Committee* consisting of ACI, ASCE and The Masonry Society (TMS), and presents allowable stress design as well as limit state (strength) design.

### Materials

$f'_m$  = masonry prism compressive strength from testing

Reinforcing steel grades are the same as those used for reinforced concrete beams.

Units can be brick, concrete or stone.

Mortar consists of masonry cement, lime, sand, and water. Grades are named from the word MASONWORK, with average strengths of 2500psi, 1800 psi, 750 psi, 350 psi, and 75 psi, respectively.

Grout is a flowable mortar, usually with a high amount of water to cement material. It is used to fill voids and bond reinforcement.

Clay and concrete masonry units are porous, and their durability with respect to weathering is an important consideration. The amount of water in the mortar is important as well as the absorption capacity of the units for good *bond*; both for strength and for weatherproofing. Because of the moisture and tendency for shrinkage and swelling, it is critical to provide control joints for expansion and contraction.

### Sizes

Common sizes for clay brick and concrete masonry units (CMU) are shown in the figure, along with definitions.

Typical section properties for CMU's are provided for reference at the end of the document.

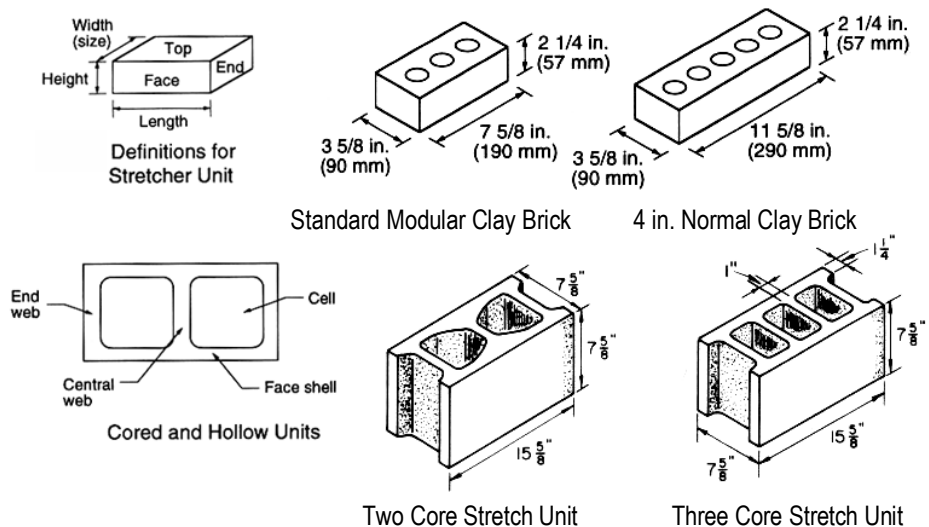

### Allowable Stress Design

For unreinforced masonry, like masonry walls, tension stresses are allowed in flexure. Masonry walls typically see compression stresses too.

For reinforced masonry, the steel is presumed to resist *all* tensile stresses and the tension in the masonry is ignored.

Factors of Safety are applied to the limit stresses for allowable stress values:

bending (unreinforced)	$F_b = 1/3 f'_m$
bending (reinforced)	$F_b = 0.45 f'_m$
bending (tension/unreinforced)	table 2.2.3.2
beam shear (unreinforced for flexure)	$F_v = 1.5 \sqrt{f'_m} \leq 120 \text{ psi}$
beam shear (reinforced) – $M/(Vd) \leq 0.25$	$F_v = 3.0 \sqrt{f'_m}$
beam shear (reinforced) – $M/(Vd) \geq 1.0$	$F_v = 2.0 \sqrt{f'_m}$
Grades 40 or 50 reinforcement	$F_s = 20 \text{ ksi}$
Grades 60 reinforcement	$F_s = 32 \text{ ksi}$
Wire joint reinforcement	$F_s = 30 \text{ ksi}$

where  $f'_m$  = specified compressive strength of masonry

*Internal Equilibrium for Bending*

$C_m =$  compression in masonry = stress x area =  $f'_m \frac{b(kd)}{2}$

$T_s =$  tension in steel = stress x area =  $A_s f_s$

$C_m = T_s$  and •

$M_m = T_s(d-kd/3) = T_s(jd)$

$M_s = C_m(jd)$

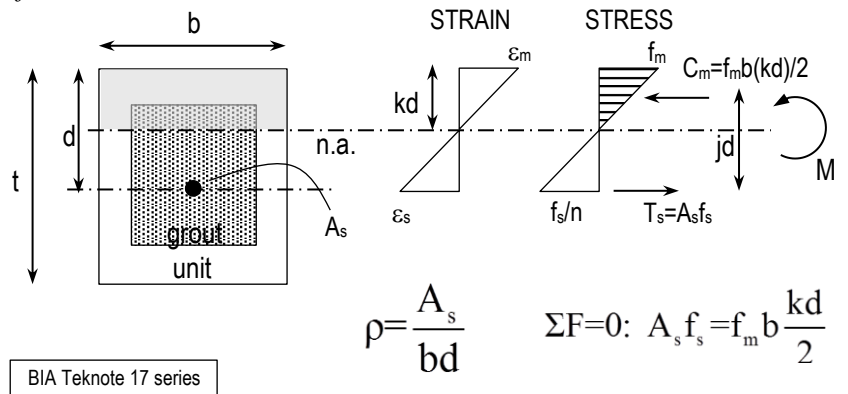

where

$f'_m$  = compressive stress in the masonry from flexure

$f_s$  = tensile stress in the steel reinforcement

$kd$  = the height to the neutral axis

$b$  = width of stress area

$d$  = effective depth of section = depth to n.a. of reinforcement

$jd$  = moment arm from tension force to compression force

$A_s$  = area of steel

$n = E_s/E_m$  used to transform steel to equivalent area of masonry for elastic stresses

$\rho$  = reinforcement ratio

**Criteria for Beam Design**

For flexure design:

$$M_m = f_m b \frac{kd}{2} jd = 0.5 f_m b d^2 jk \text{ or } M_s = A_s f_s jd = \rho b d^2 j f_s$$

The design is adequate when  $f_b \leq F_b$  in the masonry and  $f_s \leq F_s$  in the steel.

Shear stress is determined by  $f_v = V/A_{nv}$  where  $A_{nv}$  is net shear area. Shear strength is determined from the shear capacity of the masonry and the stirrups:  $F_v = F_{vm} + F_{vs}$ . Stirrup spacings are limited to  $d/2$  but not to exceed 48 in.

where:

$$F_{vm} = \frac{1}{2} \left[ \left( 4.0 - 1.75 \left( \frac{M}{Vd} \right) \right) \sqrt{f'_m} \right] + 0.25 \frac{P}{A_n} \text{ where } M/(Vd) \text{ is positive and cannot exceed } 1.0$$

$$F_{vs} = 0.5 \left( \frac{A_v F_s d}{A_{nv} s} \right) \quad (F_v = 3.0 \sqrt{f'_m} \text{ when } M/(Vd) \geq 0.25)$$

$$(F_v = 2.0 \sqrt{f'_m} \text{ when } M/(Vd) \geq 1.0.) \text{ Values can be linearly interpolated.}$$

Load and Resistance Factor Design

The design methodology is similar to reinforced concrete ultimate strength design. It is useful with high shear values and for seismic design. The limiting masonry strength is  $0.80f'_m$ .

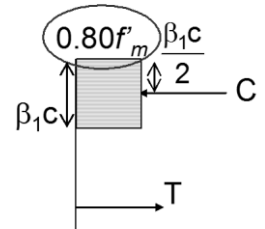

**Criteria for Column Design**

(Masonry Joint Code Committee) Building Code Requirements and Commentary for Masonry Structures define a column as having  $b/t < 3$  and  $h/t > 4$ .

where

- b = width of the “wall”
- t = thickness of the “wall”
- h = height of the “wall”

A slender column has a minimum dimension of 8” on one side and  $h/t \leq 25$ .

Columns must be reinforced, and have ties. A minimum eccentricity (causing bending) of 0.1 times the side dimension is required.

*Allowable Axial Load for Reinforced Masonry*

$$P_a = [0.25 f'_m A_n + 0.65 A_{st} F_s] \left[ 1 - \left( \frac{h}{140r} \right)^2 \right] \text{ for } h/t \leq 99$$

$$P_a = [0.25 f'_m A_n + 0.65 A_{st} F_s] \left( \frac{70r}{h} \right)^2 \text{ for } h/t > 99$$

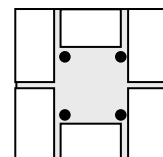

*Allowable Axial Stresses for Unreinforced Masonry (walls **only**)*

$$F_a = 0.25 f'_m \left[ 1 - \left( \frac{h}{140r} \right)^2 \right] \quad \text{for } h/t \leq 99$$

$$F_a = 0.25 f'_m \left( \frac{70r}{h} \right)^2 \quad \text{for } h/t > 99$$

where

h = effective length

r = radius of gyration

A<sub>n</sub> = effective (or net) area of masonry

A<sub>st</sub> = area of steel reinforcement

f'<sub>m</sub> = specified masonry compressive strength

F<sub>s</sub> = allowable compressive stress in column reinforcement with lateral confinement.

The least radius of gyration can be found with  $\sqrt{\frac{I}{A}}$  for a rectangle with side dimensions of b & d as:

$$r = \sqrt{\frac{db^3}{bd}} = \sqrt{\frac{b^2}{12}} = \frac{b}{\sqrt{12}}$$

where b is the smaller of the two side dimensions.

Combined Stresses

When maximum moment occurs somewhere other than at the end of the column or wall, a “virtual” eccentricity can be determined from  $e = M/P$ .

Masonry Columns and Walls

There are no modification factors, but in addition to satisfying  $\frac{f_a}{F_a} + \frac{f_b}{F_b} \leq 1.0$ , the tensile stress cannot exceed the allowable:  $f_b - f_a \leq F_t$  or the compressive stress exceed allowable for reinforced masonry:  $f_a + f_b \leq F_b$  provided  $f_a \leq F_a$ .

Example 1

Determine if the unreinforced CMU wall can sustain its loads with the wind. Specify a mortar type and unit strength per MSJC.

$$\frac{f_a}{F_a} + \frac{f_b}{F_b} \leq 1.0 \quad F_b = \frac{1}{3} f'_m \quad f_b = \frac{M}{S} \quad f_a = \frac{P}{A}$$

$$F_a = 0.25 f'_m \left[ 1 - \left( \frac{h}{140r} \right)^2 \right] \text{ for } \frac{h}{r} \leq 99$$

$$F_a = 0.25 f'_m \left( \frac{70r}{h} \right)^2 \text{ for } \frac{h}{r} > 99$$

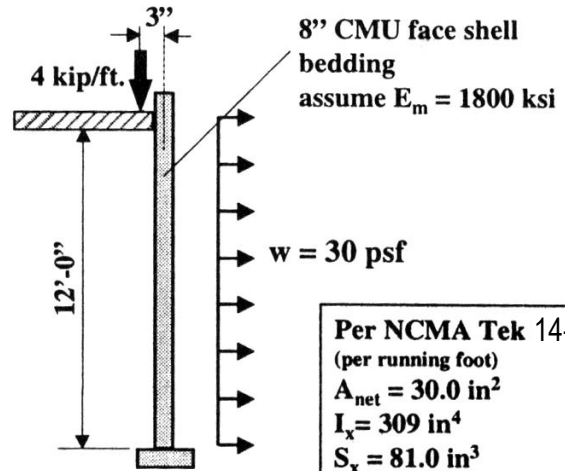

$$\frac{h}{r} = \frac{12 \text{ ft} (12 \text{ in})}{3.21 \text{ in}} = 44.9 \text{ so } F_a = 0.25 f'_m \left[ 1 - \left( \frac{12 \cdot 12 \text{ in}}{140 \cdot 3.21 \text{ in}} \right)^2 \right] = 0.224 f'_m$$

$$f_a = \frac{4k(1000 \text{ lb/k})}{30 \text{ in}^2} = 133 \text{ psi}$$

**Case "A" with wind**

at midheight of wall : (1 ft-kips/ft<sup>2</sup>) (ft) (in/ft)

$$M = \frac{Pe}{2} + \frac{wh^2}{8} = \frac{4 \text{ kip} \times 3'}{2} + \left[ \frac{(0.030)(12)^2}{8} \right] \times 12 = 12.5 \text{ kip-in.}$$

$$f_b = \frac{12,500 \text{ lb-in}}{81.0 \text{ in}^3} = 154 \text{ psi} \quad f_b \leq 1/3 f'_m$$

$$\text{tension criterion : } f'_m \geq 154 / (1/3) = 462 \text{ psi}$$

$$-f_a + f_b \leq F_t$$

$$-133 \text{ psi} + 154 \text{ psi} = 21 \text{ psi}$$

$$F_{t, req'd} = 21 \text{ psi}$$

compression criterion :

$$\frac{f_a}{F_a} + \frac{f_b}{F_b} < 1. \quad \frac{133}{0.224 f'_m} + \frac{154}{0.333 f'_m} \leq 1; \quad f'_m \geq 1056 \text{ psi}$$

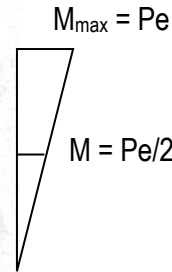

Moment distribution from eccentricity

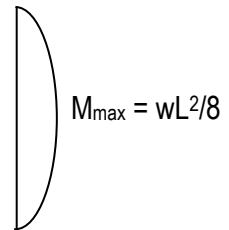

Moment distribution from distributed wind load

**Case "B" without wind**

at top of wall :  $M = Pe = 12.0 \text{ kip-in.}$

$$f_b = 12,000 \text{ lb-in} / 81 \text{ in}^3 = 148 \text{ psi}$$

$$\text{tension criterion : } -f_a + f_b \leq F_t$$

$$-133 \text{ psi} + 148 \text{ psi} \leq 15 \text{ psi} \quad F_{t, req'd} \geq 15 \text{ psi}$$

Per MSJC Table 2.2.3.2, use PCL Type N mortar  $F_t = 25 \text{ psi}$

$$\text{compression criterion : } \frac{f_a}{F_a} + \frac{f_b}{F_b} \leq 1.0$$

$$\frac{133}{0.224 f'_m} + \frac{148}{0.333 f'_m} \leq 1.00 \quad f'_m \geq 1038 \text{ psi} \quad \boxed{f'_m = 1056 \text{ psi (governs)}}$$

**Table 2.2.3.2 — Allowable flexural tensile stresses for clay and concrete masonry, psi (kPa)**

Direction of flexural tensile stress and masonry type	Mortar types			
	Portland cement/lime or mortar cement		Masonry cement or air entrained portland cement/lime	
	M or S	N	M or S	N
Normal to bed joints				
Solid units	53 (366)	40 (276)	32 (221)	20 (138)
Hollow units <sup>1</sup>				
UngROUTED	33 (228)	25 (172)	20 (138)	12 (83)
Fully grouted	86 (593)	84 (579)	81 (559)	77 (531)
Parallel to bed joints in running bond				
Solid units	106 (731)	80 (552)	64 (441)	40 (276)
Hollow units				
UngROUTED and partially grouted	66 (455)	50 (345)	40 (276)	25 (172)
Fully grouted	106 (731)	80 (552)	64 (441)	40 (276)
Parallel to bed joints in masonry not laid in running bond				
Continuous grout section parallel to bed joints	133 (917)	133 (917)	133 (917)	133 (917)
Other	0 (0)	0 (0)	0 (0)	0 (0)

<sup>1</sup> For partially grouted masonry, allowable stresses shall be determined on the basis of linear interpolation between fully grouted hollow units and ungrouted hollow units based on amount (percentage) of grouting.