

**ELEMENTS OF ARCHITECTURAL STRUCTURES:
FORM, BEHAVIOR, AND DESIGN**

ARCH 614

DR. ANNE NICHOLS

SPRING 2019

lecture
twenty one



<http://nisee.berkeley.edu/godden>

**concrete construction:
materials & beams**

Concrete Beam Design

- *composite of concrete and steel*
- *American Concrete Institute (ACI)*
 - *design for maximum stresses*
 - *limit state design*
 - *service loads x load factors*
 - *concrete holds no tension*
 - *failure criteria is yield of reinforcement*
 - *failure capacity x reduction factor*
 - *factored loads < reduced capacity*
 - *concrete strength = f'_c*

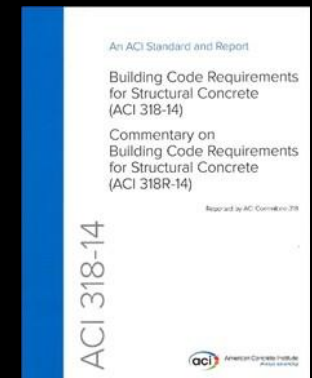

Concrete Construction

- *cast-in-place*
- *tilt-up*
- *prestressing*
- *post-tensioning*

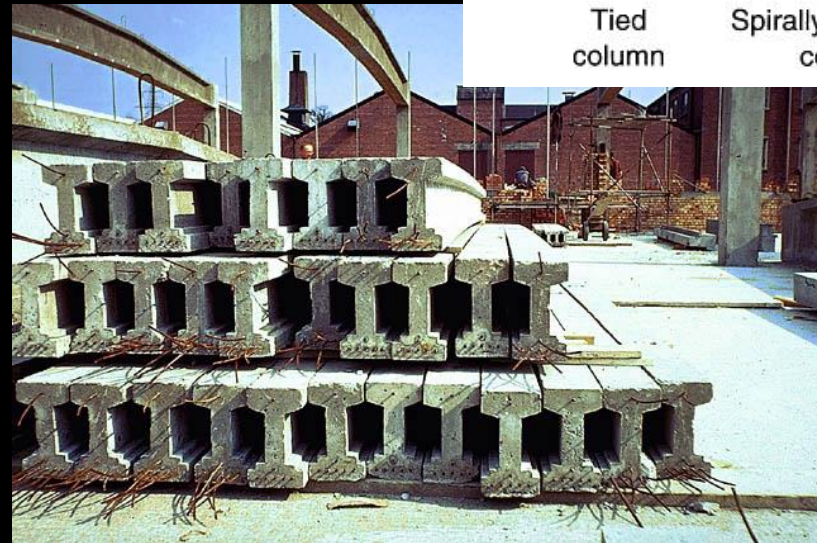
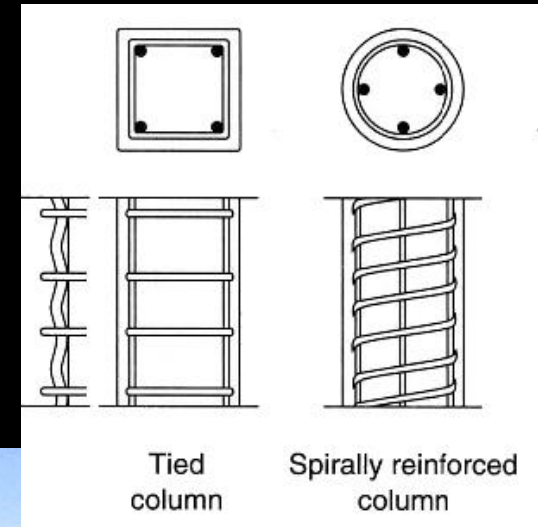

<http://nisee.berkeley.edu/godden>

Elements of Architectural Structures
ARCH 614

Concrete Beams 3
Lecture 21

S2018abn

Concrete

- *low strength to weight ratio*
- *relatively inexpensive*
 - *Portland cement*
 - *aggregate*
 - *water*
- *hydration*
- *fire resistant*
- *creep & shrink*

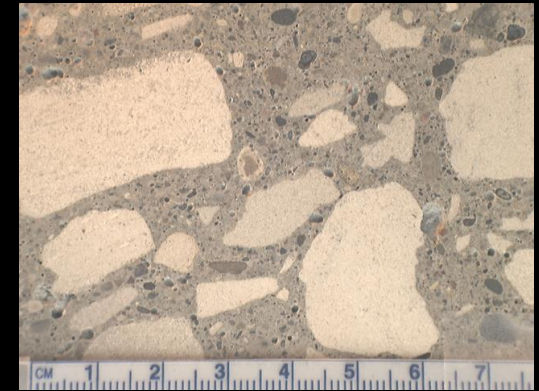

Reinforcement

- *deformed steel bars (rebar)*
 - Grade 40, $F_y = 40$ ksi
 - Grade 60, $F_y = 60$ ksi - most common
 - Grade 75, $F_y = 75$ ksi
 - US customary in # of 1/8" ϕ
(nominal)
- *longitudinally placed*
 - bottom
 - top for compression reinforcement
 - spliced, hooked, terminated...



Behavior of Composite Members

- *plane sections remain plane*
- *stress distribution changes*

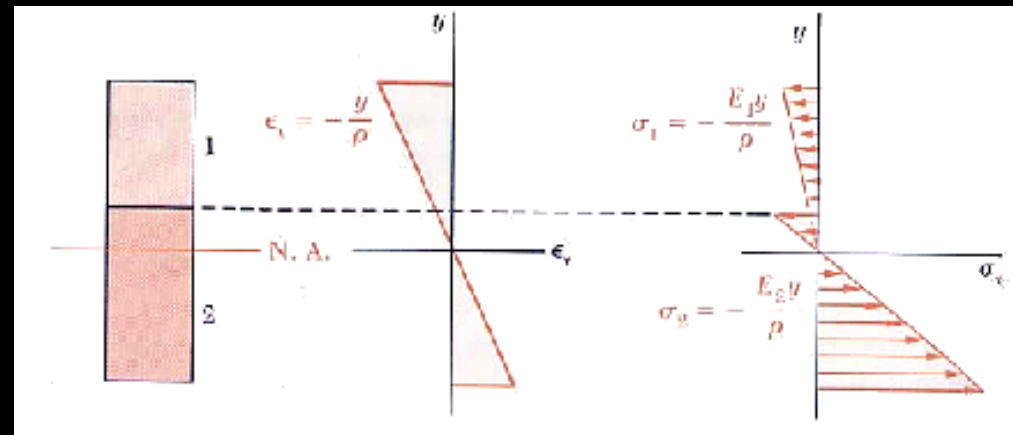
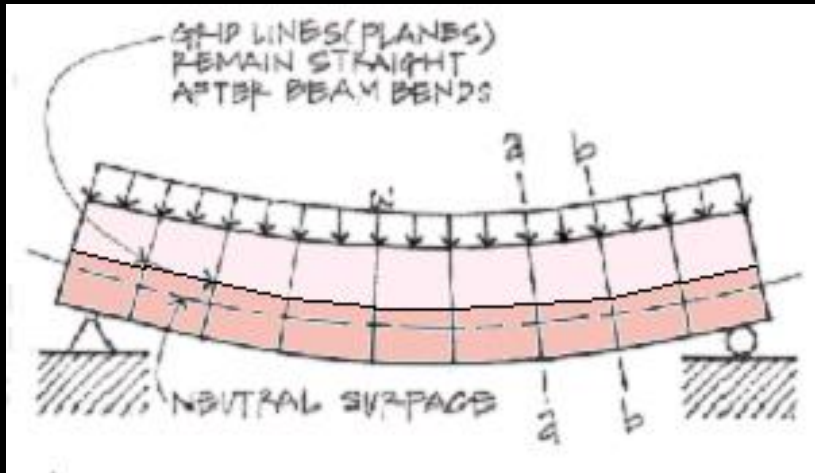

$$f_1 = E_1 \epsilon = -\frac{E_1 y}{R}$$

$$f_2 = E_2 \epsilon = -\frac{E_2 y}{R}$$

Transformation of Material

- n is the ratio of E 's*

$$n = \frac{E_2}{E_1}$$

- effectively widens a material to get same stress distribution*

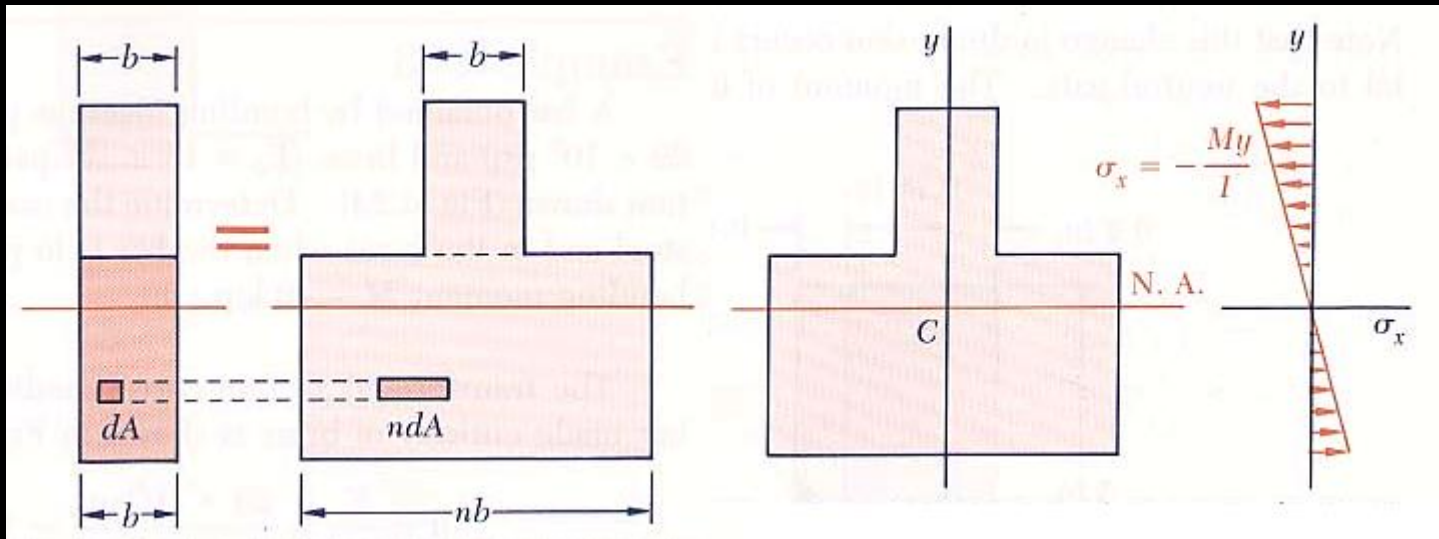

Stresses in Composite Section

- *with a section transformed to one material, new I*
 - *stresses in that material are determined as usual*
 - *stresses in the other material need to be adjusted by n*

$$n = \frac{E_2}{E_1} = \frac{E_{steel}}{E_{concrete}}$$

$$f_c = -\frac{My}{I_{transformed}}$$

$$f_s = -\frac{Myn}{I_{transformed}}$$

Reinforced Concrete - stress/strain

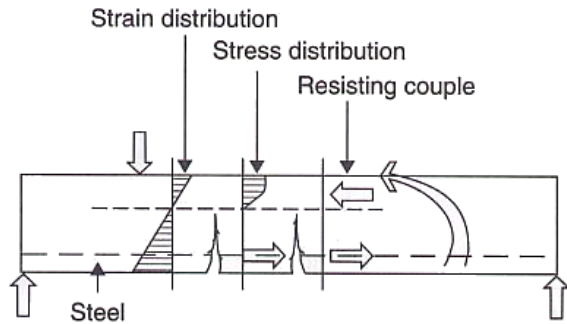

Stresses in the concrete above the neutral axis are compressive and nonlinearly distributed. In the tension zone below the neutral axis, the concrete is assumed to be cracked and the tensile force present to be taken up by reinforcing steel.

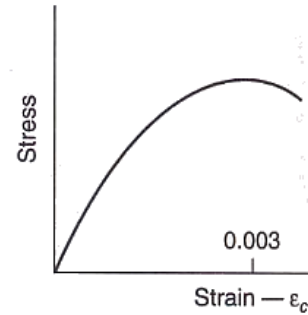

Typical stress-strain curve for concrete.

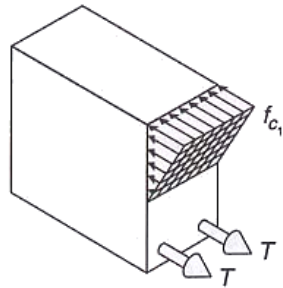

Working stress analysis. (Concrete stress distribution is assumed to be linear. Service loads are used in calculations.)

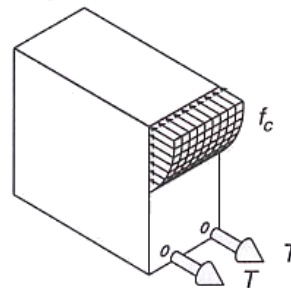

Actual stress distribution near ultimate strength (nonlinear).

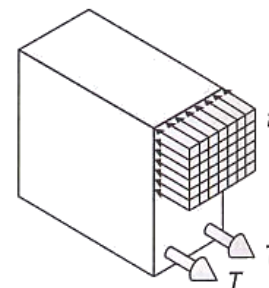

Ultimate strength analysis. (A rectangular stress block is used to idealize the actual stress distribution. Calculations are based on ultimate loads and failure stresses.)

FIGURE 6-37 Reinforced concrete beams.

Reinforced Concrete Analysis

- *for stress calculations*
 - *steel is transformed to concrete*
 - *concrete is in compression above n.a. and represented by an equivalent stress block*
 - *concrete takes no tension*
 - *steel takes tension*
 - *force ductile failure*

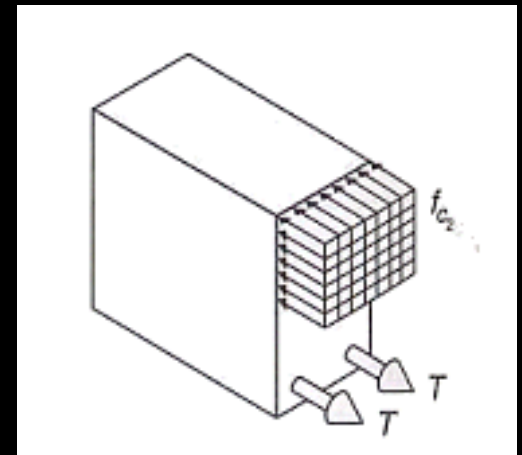

Location of n.a.

- ignore concrete below n.a.
- transform steel
- same area moments, solve for x

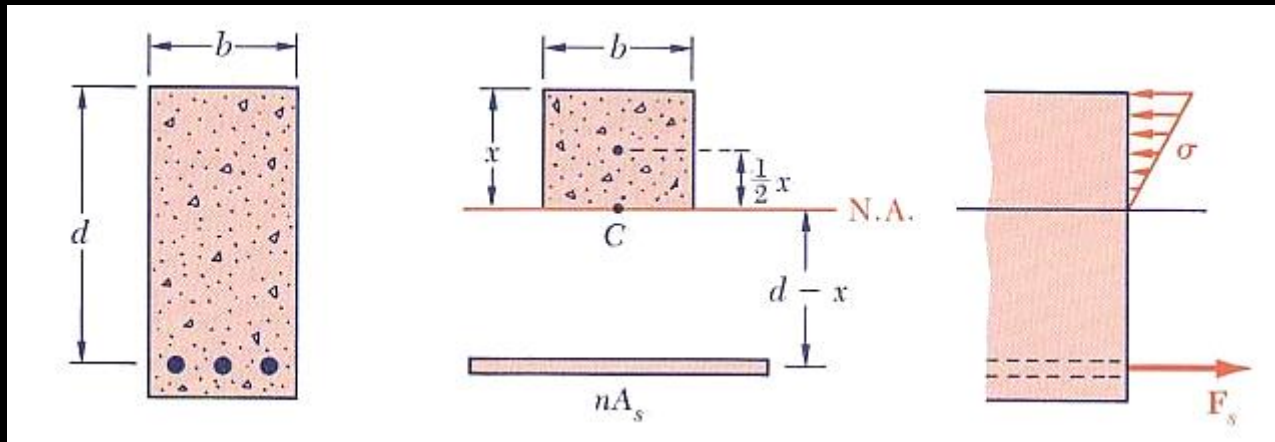

$$bx \cdot \frac{x}{2} - nA_s (d - x) = 0$$

T sections

- n.a. equation is different if n.a. below flange*

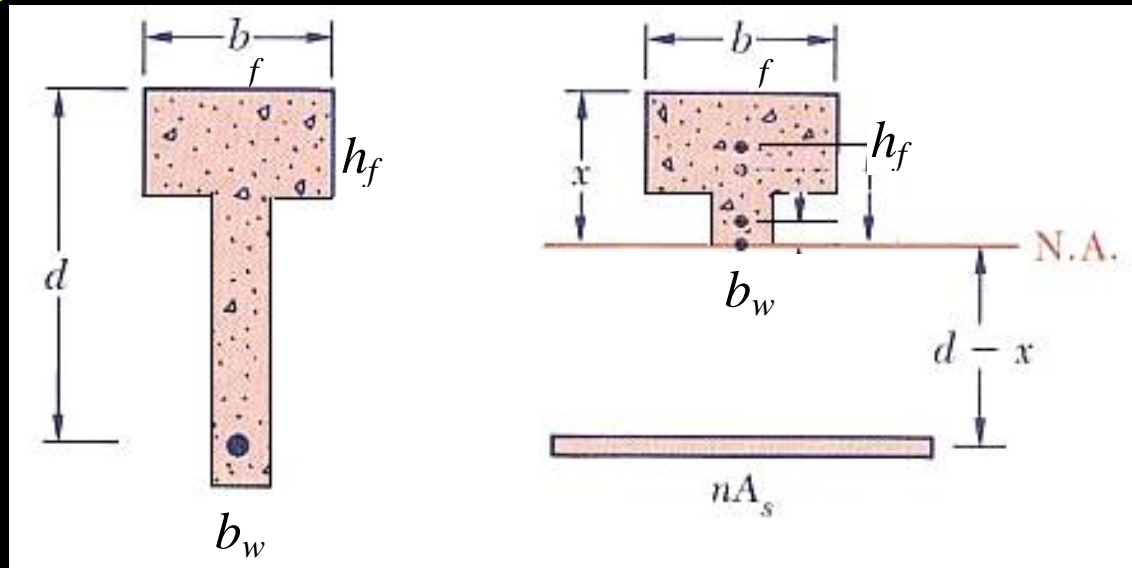

$$b_f h_f \left(x - \frac{h_f}{2} \right) + (x - h_f) b_w \frac{(x - h_f)}{2} - nA_s (d - x) = 0$$

ACI Load Combinations*

- $1.4D$
- $1.2D + 1.6L + 0.5(L_r \text{ or } S \text{ or } R)$
- $1.2D + 1.6(L_r \text{ or } S \text{ or } R) + (1.0L \text{ or } 0.5W)$
- $1.2D + 1.0W + 1.0L + 0.5(L_r \text{ or } S \text{ or } R)$
- $1.2D + 1.0E + 1.0L + 0.2S$
- $0.9D + 1.0W$
- $0.9D + 1.0E$

**can also use old
ACI factors*

Reinforced Concrete Design

- *stress distribution in bending*

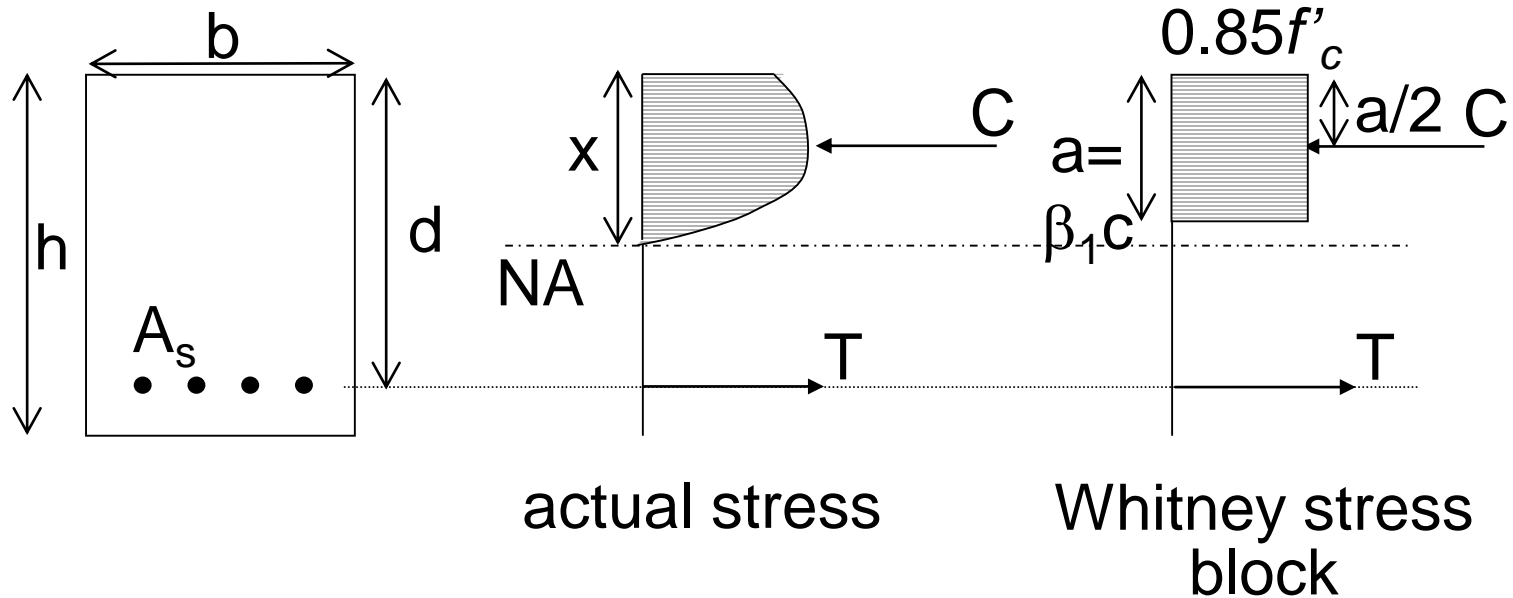

Wang & Salmon, Chapter 3

Force Equations

- $C = 0.85 f'_c b a$
- $T = A_s f_y$
- *where*
 - f'_c = concrete compressive strength
 - a = height of stress block
 - β_1 = factor based on f'_c
 - c = location to the n.a.
 - b = width of stress block
 - f_y = steel yield strength
 - A_s = area of steel reinforcement

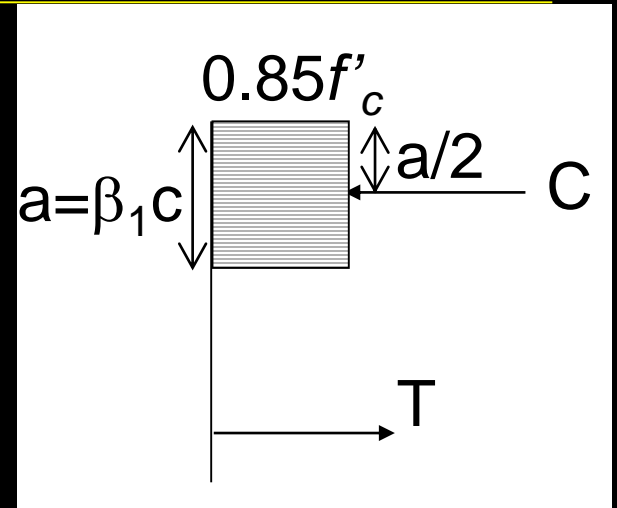

Equilibrium

- $T = C$
- $M_n = T(d - a/2)$
 - $d =$ depth to the steel n.a.
- with A_s
 - $a = \frac{A_s f_y}{0.85 f'_c b}$
 - $M_u \leq \phi M_n$ $\phi = 0.9$ for flexure
 - $\phi M_n = \phi T(d - a/2) = \phi A_s f_y (d - a/2)$

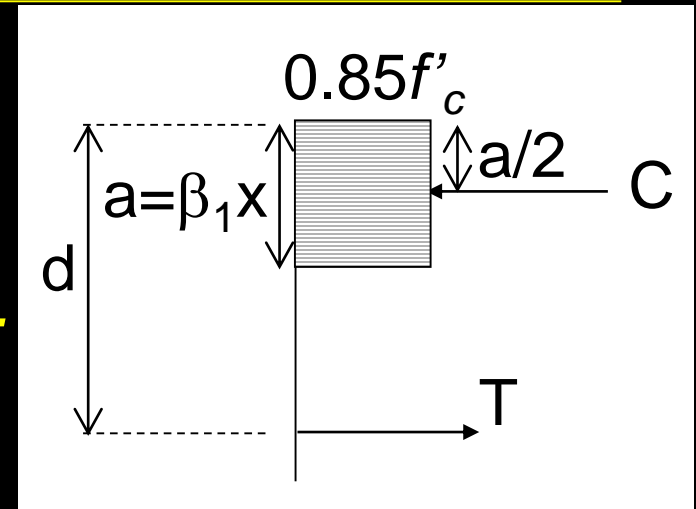

Over and Under-reinforcement

- *over-reinforced*
 - *steel won't yield*
- *under-reinforced*
 - *steel will yield*
- *reinforcement ratio*

- $$\rho = \frac{A_s}{bd}$$

- *use as a design estimate to find A_s, b, d*

- *max ρ is found with $\epsilon_{steel} \geq 0.004$ (not ρ_{bal})*

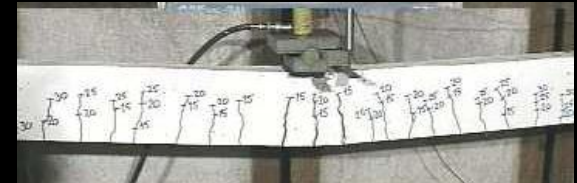
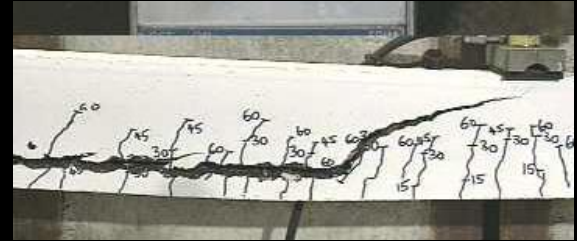

http://people.bath.ac.uk/abstji/concrete_video/virtual_lab.htm

A_s for a Given Section

- *several methods*

- *guess a and iterate*

1. *guess a (less than n.a.)*

2.
$$A_s = \frac{0.85 f'_c b a}{f_y}$$

3. *solve for a from $M_u = \phi A_s f_y (d-a/2)$*

$$a = 2 \left(d - \frac{M_u}{\phi A_s f_y} \right)$$

4. *repeat from 2. until a from 3. matches a in 2.*

A_s for a Given Section (cont)

- *chart method*

- *Wang & Salmon Fig. 3.8.1 R_n vs. ρ*

1. *calculate $R_n = \frac{M_n}{bd^2}$*

2. *find curve for f'_c and f_y to get ρ*

3. *calculate A_s and a*

- *simplify by setting $h = 1.1d$*

Reinforcement

- *min for crack control*
- *required*
$$A_s = \frac{3\sqrt{f'_c}}{f_y} (bd)$$
- *not less than*
$$A_s = \frac{200}{f_y} (bd)$$
- $A_{s-max} : a = \beta_1(0.375d)$
- *typical cover*
 - 1.5 in, 3 in with soil
- *bar spacing*

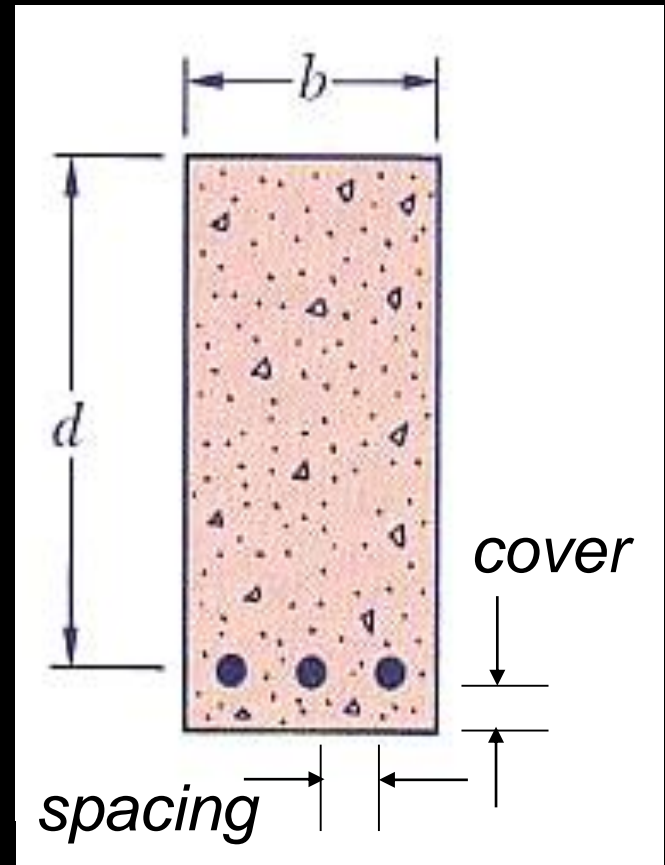

Approximate Depths

