

lecture
fourteen

wood construction:
column design

Wood Columns 1
Lecture 14

Elements of Architectural Structures
ARCH 614



S2009abn

Compression Members (revisited)

- designed for strength & stresses
- designed for serviceability & deflection
- need to design for stability
 - ability to support a specified load without sudden or unacceptable deformations

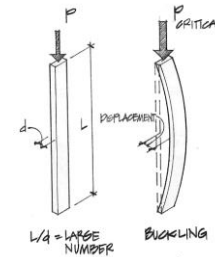

Wood Columns 2
Lecture 14

Elements of Architectural Structures
ARCH 614

S2007abn

Effect of Length (revisited)

- long & slender
- short & stubby

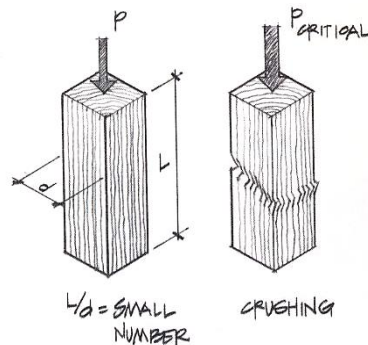
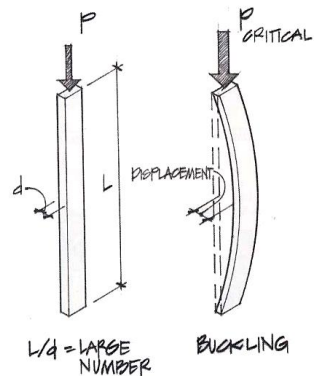

Wood Columns 3
Lecture 14

Elements of Architectural Structures
ARCH 614

S2007abn

Critical Stresses (revisited)

- when a column gets stubby, crushing will limit the load
- real world has loads with eccentricity

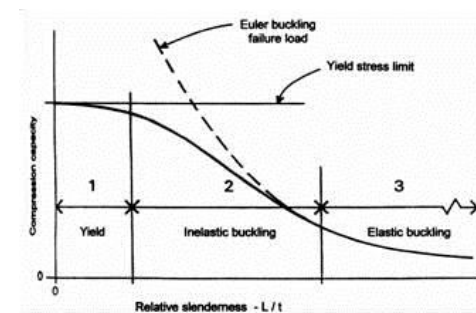

Wood Columns 4
Lecture 14

Elements of Architectural Structures
ARCH 614

S2007abn

Bracing (revisited)

- bracing affects shape of buckle in one direction
- both should be checked!

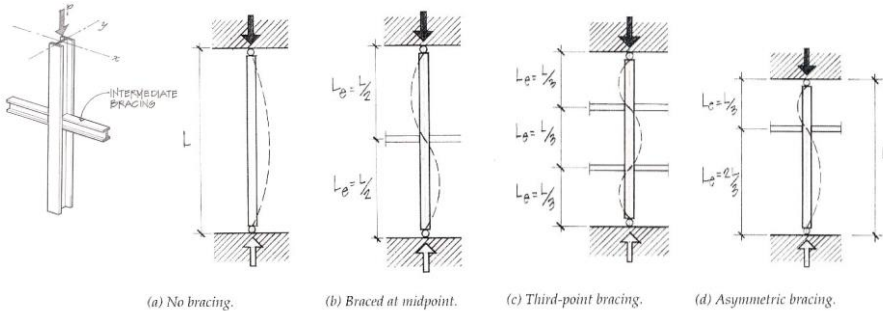

Wood Columns 5
Lecture 14

Elements of Architectural Structures
ARCH 614

S2007abn

Allowable Wood Stress

$$F'_c = F_c (C_D)(C_M)(C_t)(C_F)(C_p)$$

• where:

F_c = compressive strength parallel to grain

C_D = load duration factor

C_M = wet service factor (1.0 dry)

C_t = temperature factor

C_F = size factor

C_p = column stability factor = $f\left(\frac{F_{cE}}{F_c^*}\right)$

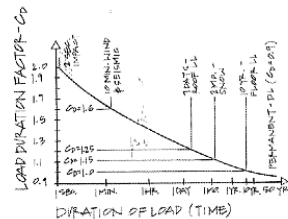

(Table 5.2)

Wood Columns 7
Lecture 14

Elements of Architectural Structures
ARCH 614

S2007abn

Wood Columns

- slenderness ratio = $L/d_{min} = L/d_1$
 - d_1 = smaller dimension
 - $l_e/d \leq 50$ (max)

$$f_c = \frac{P}{A} \leq F'_c$$

- where F'_c is the allowable compressive strength parallel to the grain
- bracing common

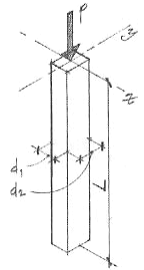

Wood Columns 6
Lecture 14

Elements of Architectural Structures
ARCH 614

S2007abn

Strength Factors

- wood properties and load duration, C_D
 - short duration
 - higher loads
 - normal duration
 - > 10 years

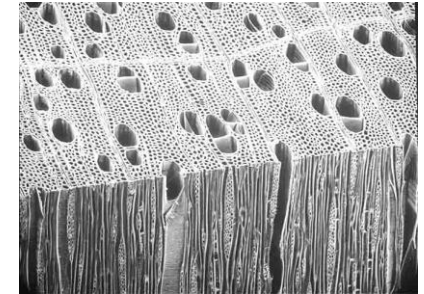

<http://www.swst.org/teach/set2/struct1.html>

- stability, C_p
 - combination curve - tables

$$F'_c = F_c^* C_p = (F_c C_D) C_p$$

Wood Columns 8
Lecture 14

Elements of Architectural Structures
ARCH 614

S2007abn

C_p Charts

Column Stability Factor C_p

C _p			F _c = C _p · F _c *			F _{cE} = $\frac{0.822E'_{min}}{(L_e/d)^2}$ (c = 0.8 sawn, c = 0.9 glulam)		
F _{cE} /F _c *	Sawn C _p	Glulam C _p	F _{cE} /F _c *	Sawn C _p	Glulam C _p	F _{cE} /F _c *	Sawn C _p	Glulam C _p
0.00	0.000	0.000	0.60	0.500	0.578	1.20	0.750	0.822
0.01	0.010	0.010	0.61	0.506	0.545	1.22	0.755	0.826
0.02	0.020	0.020	0.62	0.512	0.552	1.24	0.760	0.831
0.03	0.030	0.030	0.63	0.518	0.559	1.26	0.764	0.836
0.04	0.040	0.040	0.64	0.524	0.566	1.28	0.769	0.840
0.05	0.049	0.050	0.65	0.530	0.573	1.30	0.773	0.844
0.06	0.059	0.060	0.66	0.536	0.580	1.32	0.777	0.848
0.07	0.069	0.069	0.67	0.542	0.587	1.34	0.781	0.852
0.08	0.079	0.079	0.68	0.548	0.593	1.36	0.785	0.855
0.09	0.088	0.089	0.69	0.553	0.600	1.38	0.789	0.859
0.10	0.098	0.099	0.70	0.559	0.607	1.40	0.793	0.862
0.11	0.107	0.109	0.71	0.564	0.613	1.42	0.796	0.865
0.12	0.117	0.118	0.72	0.569	0.619	1.44	0.800	0.868
0.13	0.126	0.128	0.73	0.575	0.626	1.46	0.803	0.871
0.14	0.136	0.138	0.74	0.580	0.632	1.48	0.807	0.874
0.15	0.145	0.147	0.75	0.585	0.638	1.50	0.810	0.877
0.16	0.154	0.157	0.76	0.590	0.644	1.52	0.813	0.879
0.17	0.164	0.167	0.77	0.595	0.650	1.54	0.816	0.882
0.18	0.173	0.175	0.78	0.600	0.655	1.56	0.819	0.884
0.19	0.182	0.186	0.79	0.605	0.661	1.58	0.822	0.887

Wood Columns 9
Lecture 14

Elements of Architectural Structures
ARCH 614

S2007abn

Procedure for Analysis

- calculate L_e/d_{min}
 - KL/d each axis, choose largest
- obtain F'_c
 - compute $F_{cE} = \frac{0.822E'_{min}}{(L_e/d)^2}$
 - where $E'_{min} = E_{min}(C_M)(C_t)(C_T)(C_i)$
- compute $F_c^* \approx F_c C_D$
- calculate F_{cE}/F_c^* and get C_p (chart)
- calculate $F'_c = F_c^* C_p$

Wood Columns 10
Lecture 14

Elements of Architectural Structures
ARCH 614

S2009abn

Procedure for Analysis (cont'd)

- compute $P_{allowable} = F'_c \cdot A$
 - or find $f_{actual} = P/A$
- is $P \leq P_{allowable}$? (or $f_{actual} \leq F'_c$?)
 - yes: OK
 - no: overstressed & no good

Wood Columns 11
Lecture 14

Elements of Architectural Structures
ARCH 614

S2007abn

Procedure for Design

- guess a size (pick a section)
- calculate L_e/d_{min}
 - KL/d each axis, choose largest
- obtain F'_c
 - compute $F_{cE} = \frac{0.822E'_{min}}{(L_e/d)^2}$
 - where $E'_{min} = E_{min}(C_M)(C_t)(C_T)(C_i)$
- compute $F_c^* \approx F_c C_D$
- calculate F_{cE}/F_c^* and get C_p (chart)

Wood Columns 12
Lecture 14

Elements of Architectural Structures
ARCH 614

S2009abn

Procedure for Design (cont'd)

6. calculate $F'_c = F_c^* C_p$
7. compute $P_{allowable} = F'_c \cdot A$
 - or find $f_{actual} = P/A$
8. is $P \leq P_{allowable}$? (or $f_{actual} \leq F'_c$?)
 - yes: OK
 - no: pick a bigger section and **go back to step 2**.

Specific Column Charts

TABLE 6.1 Safe Loads for Wood Columns*

Column Section	Area (in. ²)	Unbraced Length (ft)																				
		6	8	10	12	14	16	18	20	22	24	26										
4 × 4	12.25	11.1	7.28	4.94	3.50	2.63																
4 × 6	19.25	17.4	11.4	7.76	5.51	4.14																
4 × 8	25.375	22.9	15.1	10.2	7.26	6.46																
6 × 6	30.25	27.6	24.8	20.9	16.9	13.4	10.7	8.71	7.17	6.53												
6 × 8	41.25	37.6	33.9	28.5	23.1	18.3	14.6	11.9	9.78	8.91												
6 × 10	52.25	47.6	43.0	36.1	29.2	23.1	18.5	15.0	13.4	11.3												
8 × 8	56.25	54.0	51.5	48.1	43.5	38.0	32.3	27.4	23.1	19.7	16.9	14.6										
8 × 10	71.25	68.4	65.3	61.0	55.1	48.1	41.0	34.7	29.3	24.9	21.4	18.4										
8 × 12	86.25	82.8	79.0	73.8	66.7	58.2	49.6	42.0	35.4	30.2	26.0	22.3										
10 × 10	90.25	88.4	85.9	83.0	79.0	73.6	67.0	60.0	52.9	46.4	40.4	35.5										
10 × 12	109.25	107	104	100	95.6	89.1	81.2	72.6	64.0	56.1	48.9	42.9										
10 × 14	128.25	126	122	118	112	105	95.3	85.3	75.1	65.9	57.5	50.4										
12 × 12	132.25	130	128	125	122	117	111	104	95.6	86.9	78.3	70.2										
14 × 14	182.25	180	178	176	172	168	163	156	148	139	129	119										
16 × 16	240.25	238	236	234	230	226	222	216	208	200	190	179										

*Load capacity in kips for solid-sawn sections of No. 1 grade Douglas fir-larch with no adjustment for moisture or load duration conditions.

Timber Construction by Code

- light-frame
 - light loads
 - 2x's
 - floor joists – 2x6, 2x8, 2x10, 2x12 typical at spacings of 12", 16", 24"
 - normal spans of 20-25 ft or 6-7.5 m
 - plywood spans between joists
 - stud or load-bearing masonry walls
 - limited to around 3 stories – fire safety



Design of Columns with Bending

- satisfy
 - strength
 - stability
- pick
 - section

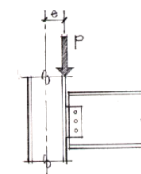

(a) Framed beam (shear) connection.
 $e =$ Eccentricity; $M = P \times e$

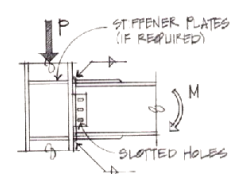

(b) Moment connection (rigid frame).
 $M =$ Moment due to beam bending

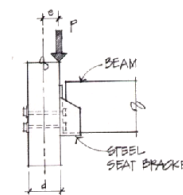

(c) Timber beam-column connection.
 $e = d/2 =$ eccentricity; $M = P \times e$

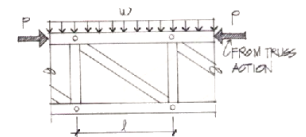

(d) Upper chord of a truss—compression plus bending.
 $M = \frac{wl^2}{8}$

Design

- Wood

$$\left[\frac{f_c}{F'_c} \right]^2 + \frac{f_{bx}}{F'_{bx} \left(1 - \frac{f_c}{F_{cEx}} \right)} \leq 1.0$$

() term – magnification factor for P-Δ

F'_{bx} – allowable bending strength

Design Steps Knowing Loads

1. assume limiting stress
 - buckling, axial stress, combined stress
2. solve for r , A or S
3. pick trial section
4. analyze stresses
5. section ok?
6. stop when section is ok

