

lecture  
twenty two



concrete construction:  
T-beams & slabs

Concrete Slabs 1  
Lecture 22

Elements of Architectural Structures  
ARCH 614

S2009abn

Systems

- beams separate from slab
- beams integral with slab
  - close spaced
- continuous beams
- no beams

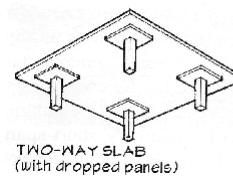
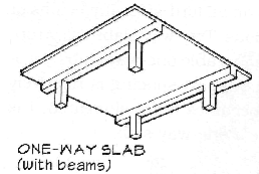

Concrete Slabs 2  
Lecture 22

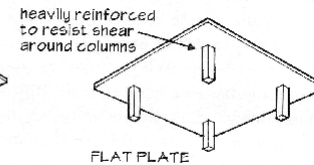

Elements of Architectural Structures  
ARCH 614

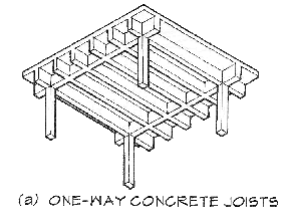

S2007abn

T sections

- two areas of compression in moment possible
- one-way joists
- effective flange width

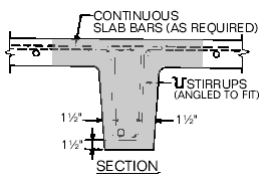

Concrete Slabs 3  
Lecture 22

Elements of Architectural Structures  
ARCH 614

S2007abn

T sections

- negative bending: min  $A_s$ , larger of:

$$A_s = \frac{6\sqrt{f'_c}}{f_y} (b_w d) \quad A_s = \frac{3\sqrt{f'_c}}{f_y} (b_f d)$$

- effective width (interior)

- $L/4$
- $b_w + 16t$
- center-to-center of beams

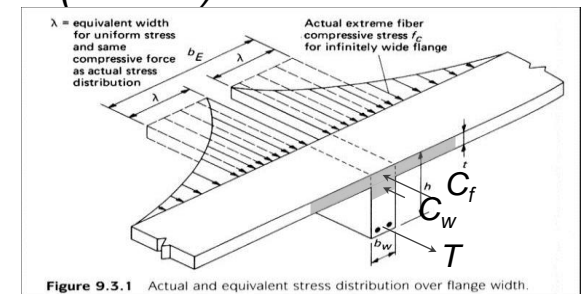

Figure 9.3.1 Actual and equivalent stress distribution over flange width.

Elements of Architectural Structures  
ARCH 614

S2007abn

Concrete Slabs 4  
Lecture 22

# T sections

- usual analysis steps
  1. assume no compression in web
  2. design like a rectangular beam
  3. needs reinforcement in slab too
  4. also analyze for negative moment, if any

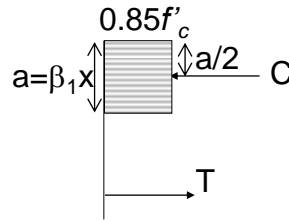

Concrete Slabs 5  
Lecture 22

Elements of Architectural Structures  
ARCH 614

S2007abn

# One-way

- Joists
  - wide pans
  - 5', 6' up
  - light loads & long spans
  - one-leg stirrups

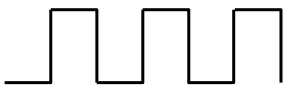

Concrete Slabs 7  
Lecture 22

Elerr.

## WIDE FLANGEforms

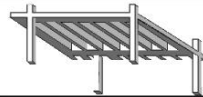

WIDE FLANGEforms are available in standard 53 and 66-inch widths. When used with 7 and 6-inch joists they produce 5 and 6-foot modules respectively. ACI 318 requires the "joist" to be designed as a beam with minimum shear reinforcement. Any joist width can be used in combination with standard width pans to address span and load requirements. This system is very efficient for projects where the structural floor must provide a two-hour fire rating.

Using hard rock concrete, a 4 1/2-inch slab and minimum slab reinforcement will result in sufficient capacity for a variety of superimposed loads while reducing structure dead load. Shallower depth forms are appropriate for spans in the 25- to 35-foot range. Deeper depths are appropriate, under moderate loads, for spans in the 35- to 45-foot range using mild steel, while spans up to 60 feet can be achieved with post-tensioning.

By varying joist widths, different loading conditions can be accommodated using standard forming equipment without the need to add drop beams. Distribution ribs, which add unnecessary cost, are not required with wide module construction.

These forms are appropriate for structural concrete only, and should not be specified for critically exposed surfaces where appearance is important. They are a segmented steel form that will impart irregular lap and flange marks to the finished concrete, though many believe the finished product is acceptable for non-critically exposed work.

If a higher quality of finish is desired, for additional cost, you may wish to consider Ceco LONGforms (please see page 6). Your Ceco representative can assist in form type selection.



Voids Created with 53" Design Module	
Depth of Void	Cubic Feet of concrete per square foot of slab thickness*
14"	not available
16"	5.79
20"	7.00
24"	8.90

Voids Created with 66" Design Module	
Depth of Void	Cubic Feet of concrete per square foot of slab thickness*
14"	4.93
16"	7.00
20"	8.90
24"	10.87

### Dimensions

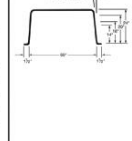
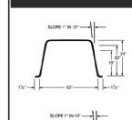

4

# One-way

- Joists
  - standard stems
  - 2.5" to 4.5" slab
  - ~30" widths
  - reusable forms

Concrete Slabs 6  
Lecture 22

Elerr.

# Compression Reinforcement

- doubly reinforced
- negative bending
- two compression forces

- $T = C_c + C_s$
- $T = A_s f_y$
- $C_s = A_s' f_y$
- $M_n = T(d-a/2) + C_s(d-d')$

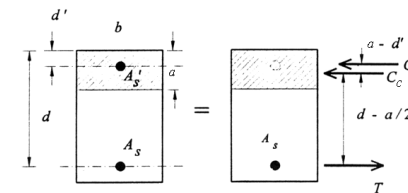

Concrete Slabs 8  
Lecture 22

Elements of Architectural Structures  
ARCH 614

S2009abn

## FLANGEforms

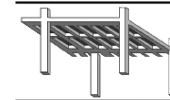

FLANGEforms are available in standard 2- and 3-foot modules. These forms are among the most popular because of their flexibility to accommodate various layouts and joist widths where required. They are efficient for projects with heavy superimposed loads and provide a two hour fire rating by using a 4 1/2-inch hard-rock concrete topping. They are efficient for projects of smaller size and for moderate size projects with irregular layouts or unusual building shapes. They are also efficient for projects where the structure is not required to provide a two-hour fire rating by using 3-inch or 3 1/2-inch top slab.

The varying depths provide flexibility to meet a wide range of spans and loads. Further, they will accommodate in-floor raceway electrical and communication distribution systems. Ceco FLANGEforms are capable of producing sound structural concrete, but are incapable of producing tight tolerances and smooth finishes. This form is a segmented steelform and the concrete will have irregular joists, a rough finish, and offsets at both the laps and flanges.

If a higher quality finish is required, you may wish to consider Ceco LONGforms (please see page 6). The additional cost of higher quality forms are often offset by finishing costs. Contact your Ceco representative for assistance.

Concrete Quantities/30" Widths*		
Depth of Void	Width of Void	Cubic Feet of concrete per square foot of slab thickness*
14"	3"	4.93
16"	3"	5.79
16"	4"	6.55
20"	3"	7.00
20"	4"	8.00
24"	3"	8.90
24"	4"	10.00

\* Apply only for areas over FLANGEforms and joists between them. Slabbing joists, special headers, beams etc., not included. 10" and 12" depths are also available. Contact your Ceco Concrete Construction Engineer.

Concrete Quantities/20" Widths*		
Depth of Void	Width of Void	Cubic Feet of concrete per square foot of slab thickness*
14"	3"	4.93
16"	3"	5.79
16"	4"	6.55
20"	3"	7.00
20"	4"	8.00
24"	3"	8.90
24"	4"	10.00

\* Apply only for areas over FLANGEforms and joists between them. Slabbing joists, special headers, beams etc., not included. 10" and 12" depths are also available. Contact your Ceco Concrete Construction Engineer.

Voids Created by Various Size FLANGEforms					
Depth of Void	Stiffener	Cubic Feet of concrete per square foot of slab thickness*			
		12" x 12"	12" x 16"	16" x 16"	16" x 24"
10"	3"	3.83	4.19	3.80	4.51
12"	3"	2.43	2.90	2.91	3.21
14"	3"	3.83	4.19	3.80	4.51
16"	3"	3.83	4.19	3.80	4.51
20"	3"	3.83	4.19	3.80	4.51
24"	3"	4.67	5.00	4.67	5.41

\* \* \* \* \* Final void width depends on Slope 30" to 25" or 20" to 25" in 12"

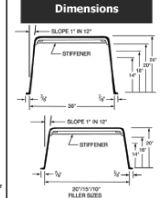

# Compression Reinforcement

- needs ties because of buckling
- simplified method in text assumes

- $A_s' = 0.3A_s$
- $M_n > M_u/\phi$
- $f_s' = 1/2f_y$
- $a = 2d'$
- so

$$A_s = \frac{M_u/\phi}{f_y(d-d')}$$

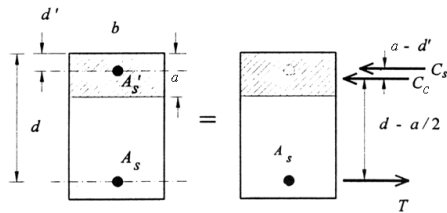

# Slabs

- one way behavior – like beams
- two way behavior – more complex

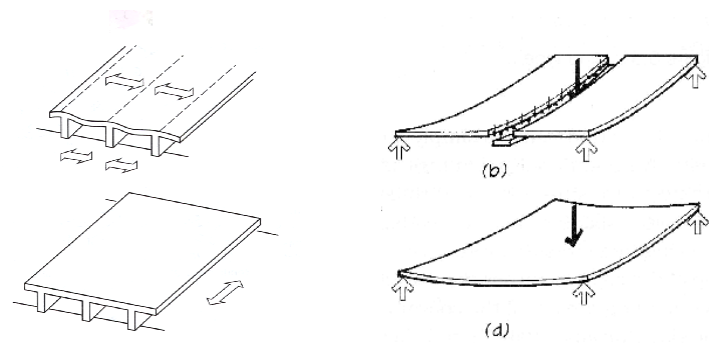

# Slab Design

- one unit wide “strip”
- with uniform loads
  - like “wide” beams
  - moment / unit width
  - uniform curvature
- with point loads
  - resisted by stiffness of adjacent strips
  - more curvature in middle

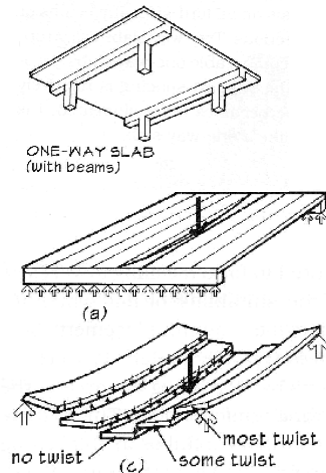

# Slab Design

- min thickness by code
- reinforcement
  - bars, welded wire mesh
  - cover
  - minimum by steel grade

- 40-50:  $\rho = \frac{A_s}{bt} = 0.002$
- 60:  $\rho = \frac{A_s}{bt} = 0.0018$

TABLE 9.5(a)—MINIMUM THICKNESS OF NONPRESTRESSED BEAMS OR ONE-WAY SLABS UNLESS DEFLECTIONS ARE COMPUTED

Member	Minimum thickness, $h$			
	Simply supported	One end continuous	Both ends continuous	Cantilever
Solid one-way slabs	$\ell/20$	$\ell/24$	$\ell/28$	$\ell/10$
Beams or ribbed one-way slabs	$\ell/16$	$\ell/18.5$	$\ell/21$	$\ell/8$

Notes:  
 1) Span length  $\ell$  is in inches.  
 2) Values given shall be used directly for members with normalweight concrete ( $w_c = 145 \text{ lb/ft}^3$ ) and Grade 60 reinforcement. For other conditions, the values shall be modified as follows:  
 a) For structural lightweight concrete having unit weight in the range 90-120 lb/ft<sup>3</sup>, the values shall be multiplied by  $(1.85 - 0.005w_c)$  but not less than 1.05, where  $w_c$  is the unit weight in lb/ft<sup>3</sup>.  
 b) For  $f_y$  other than 60,000 psi, the values shall be multiplied by  $(0.4 + f_y/100,000)$ .



# One-way Slabs

\*not in note set

- $A_s$  tables
- max spacing\*
  - $\leq 3(t)$  and 18"
  - $\leq 5(t)$  and 18" – temp & shrinkage steel
- no room for stirrups

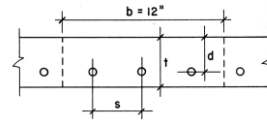

Table 3-7 Areas of Bars per Foot Width of Slab— $A_s$  (in.<sup>2</sup>/ft)

Bar size	Bar spacing (in.)												
	6	7	8	9	10	11	12	13	14	15	16	17	18
#3	0.22	0.19	0.17	0.15	0.13	0.12	0.11	0.10	0.09	0.09	0.08	0.08	0.07
#4	0.40	0.34	0.30	0.27	0.24	0.22	0.20	0.18	0.17	0.16	0.15	0.14	0.13
#5	0.62	0.53	0.46	0.41	0.37	0.34	0.31	0.29	0.27	0.25	0.23	0.22	0.21
#6	0.88	0.75	0.66	0.59	0.53	0.48	0.44	0.41	0.38	0.35	0.33	0.31	0.29
#7	1.20	1.03	0.90	0.80	0.72	0.65	0.60	0.55	0.51	0.48	0.45	0.42	0.40
#8	1.58	1.35	1.18	1.05	0.95	0.86	0.79	0.73	0.68	0.63	0.59	0.56	0.53
#9	2.00	1.71	1.50	1.33	1.20	1.09	1.00	0.92	0.86	0.80	0.75	0.71	0.67
#10	2.54	2.18	1.91	1.69	1.52	1.39	1.27	1.17	1.09	1.02	0.95	0.90	0.85
#11	3.12	2.67	2.34	2.08	1.87	1.70	1.56	1.44	1.34	1.25	1.17	1.10	1.04