

lecture
twenty six



Bright Football Complex
www.tamu.edu

concrete construction: foundation design

Foundations 1
Lecture 26

Elements of Architectural Structures
ARCH 614

S2009abn

Foundation

- the engineered interface between the earth and the structure it supports that transmits the loads to the soil or rock

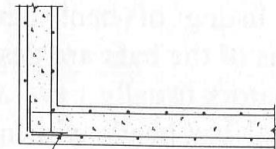

F300 Corner bars
Space same as horizontal bars
Req'd-- 5 x 11-F300
2 x 13-F300
CORNER DETAIL

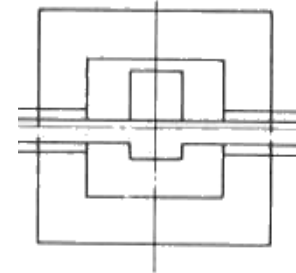

Foundations 2
Lecture 26

Elements of Architectural Structures
ARCH 614

S2007abn

Structural vs. Foundation Design

- structural design
 - choice of materials
 - choice of framing system
 - uniform materials and quality assurance
 - design largely independent of geology, climate, etc.



Foundations 3
Lecture 26

Elements of Architectural Structures
ARCH 614

S2007abn

Structural vs. Foundation Design

- foundation design
 - cannot specify site materials
 - site is usually predetermined
 - framing/structure predetermined
 - site geology influences foundation choice
 - no site the same
 - no design the same

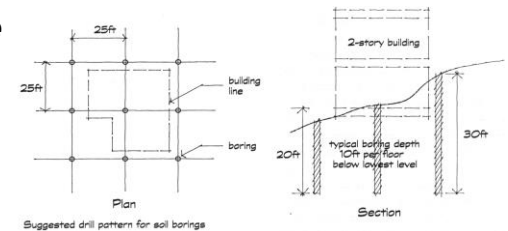

Foundations 4
Lecture 26

Elements of Architectural Structures
ARCH 614

S2007abn

Soil Properties & Mechanics

- unit weight of soil
- allowable soil pressure
- factored net soil pressure
- shear resistance
- backfill pressure
- cohesion & friction of soil
- effect of water
- settlement
- rock fracture behavior

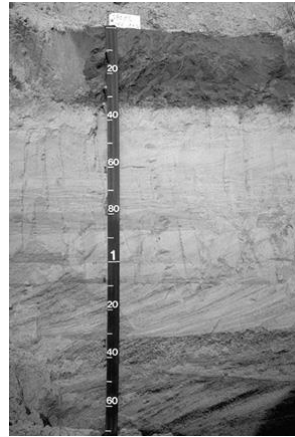

Soil Properties & Mechanics

- compressibility
 - settlements
- strength
 - stability
 - shallow foundations
 - deep foundations
 - slopes and walls
 - ultimate bearing capacity, q_u
 - allowable bearing capacity, $q_a = \frac{q_u}{S.F.}$

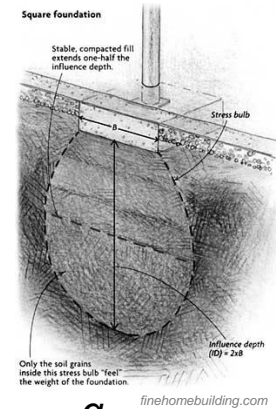

finehomebuilding.com

Soil Properties & Mechanics

- strength, q_a

Class of material	Loadbearing pressure (pounds per square foot) ^a
1. Crystalline bedrock	12,000
2. Sedimentary rock	6,000
3. Sandy Gravel	5,000
4. Sand, silty sand, clayey sand, silty gravel and clayey gravel	3,000
5. Clay, sandy clay, silty clay & clayey silt	2,000

Note a. 1 psf = 47.9 Pa.

FIGURE 2.5
Presumptive surface bearing values of various soils, as given in the BOCA National Building Code/1996. (Reproduced by permission)

Bearing Failure

- shear

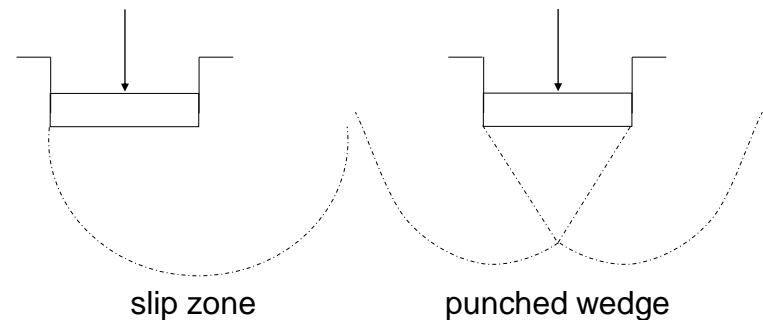

Lateral Earth Pressure

- *passive vs. active*

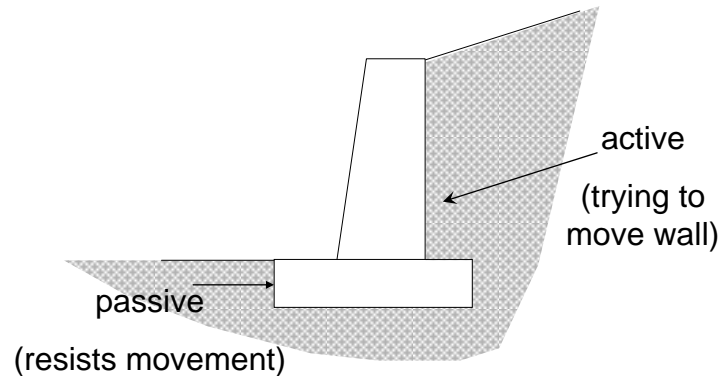

Foundations 9
Lecture 26

Elements of Architectural Structures
ARCH 614

S2007abn

Foundation Materials

- *concrete, plain or reinforced*
 - shear
 - bearing capacity
 - bending
 - embedment length, development length
- *other materials (piles)*
 - steel
 - wood
 - composite

Foundations 10
Lecture 26

Elements of Architectural Structures
ARCH 614

S2007abn

Basic Foundation Requirements

- *safe against instability or collapse*
- *no excessive/damaging settlements*
- *consider environment*
 - frost action
 - shrinkage/swelling
 - adjacent structure, property lines
 - ground water
 - underground defects
 - earthquake
- *economics*

Foundations 11
Lecture 26

Elements of Architectural Structures
ARCH 614

S2007abn

Generalized Design Steps

- *calculate loads*
- *characterize soil*
- *determine footing location and depth*
- *evaluate soil bearing capacity*
- *determine footing size (unfactored loads)*
- *calculate contact pressure and check stability*
- *estimate settlements*
- *design footing structure* (factored loads)*

Foundations 12
Lecture 26

Elements of Architectural Structures
ARCH 614

S2007abn

Types of Foundations

- spread footings
- wall footings
- eccentric footings
- combined footings
- unsymmetrical footings
- strap footings

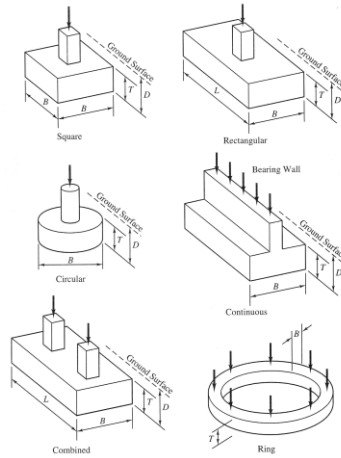

Figure 5.1 Spread footing shapes and dimensions.

Foundations 13
Lecture 26

Elements of Architectural Structures
ARCH 614

S2007abn

Types of Foundations

- mat foundations
- retaining walls
- basement walls
- pile foundations
- drilled piers

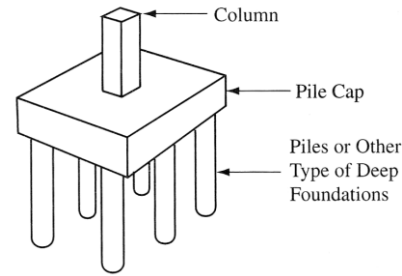

Foundations 14
Lecture 26

Elements of Architectural Structures
ARCH 614

S2007abn

Shallow Footings

- spread footing
 - a square or rectangular footing supporting a single column
 - reduces stress from load to size the ground can withstand

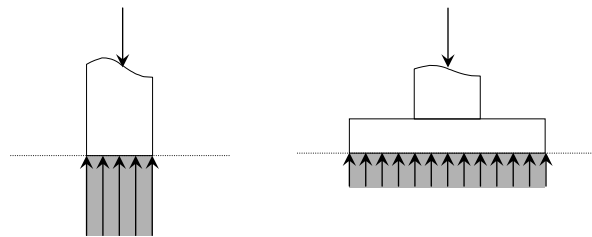

Foundations 15
Lecture 26

Elements of Architectural Structures
ARCH 614

S2007abn

Actual vs. Design Soil Pressure

- stress distribution is a function of
 - footing rigidity
 - soil behavior

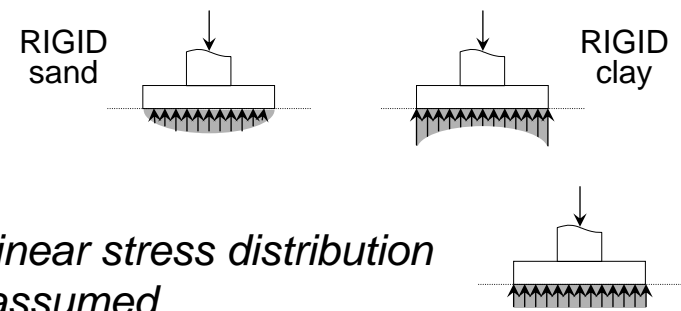

- linear stress distribution assumed

Foundations 16
Lecture 26

Elements of Architectural Structures
ARCH 614

S2007abn

Proportioning Footings

- net allowable soil pressure, q_{net}
 - $q_{net} = q_{allowable} - h_f(\gamma_c - \gamma_s)$
 - considers all extra weight (overburden) from replacing soil with concrete
 - can be more overburden

- design requirement with total unfactored load:

$$\frac{P}{A} \leq q_{net}$$

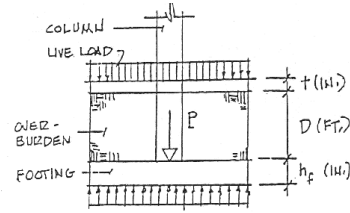

Concrete Spread Footings

- plain or reinforced
- ACI specifications
- $P_u =$ combination of factored D, L, W
- ultimate strength
 - $V_u \leq \phi V_c$: $\phi = 0.75$ for shear
 - plain concrete has shear strength
 - $M_u \leq \phi M_n$: $\phi = 0.9$ for flexure

Concrete Spread Footings

- failure modes

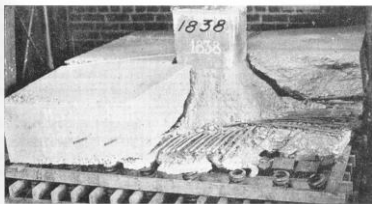

Figure 9.2 "Shear" failure in a spread footing loaded in a laboratory (Talbot, 1913). Observe how this failure actually is a combination of tension and shear.

shear

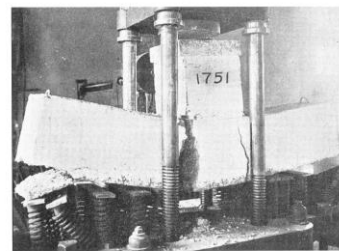
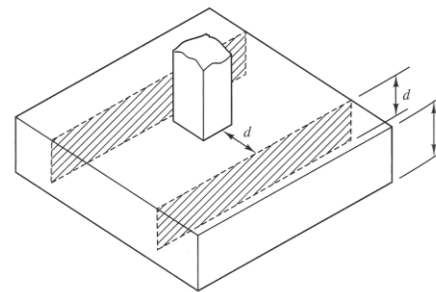

Figure 9.3 Flexural failure in a spread footing loaded in a laboratory (Talbot, 1913).

bending

Concrete Spread Footings

- shear failure



one way shear

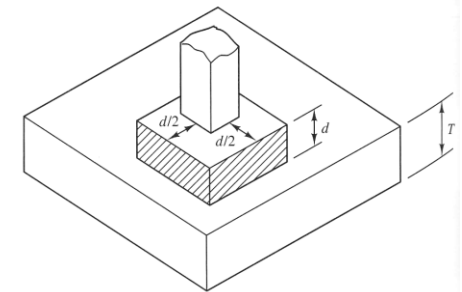

two way shear

Over and Under-reinforcement

- reinforcement ratio for bending
 - $\rho = \frac{A_s}{bd}$
 - use as a design estimate to find A_s, b, d
 - max ρ from $\epsilon_{steel} \geq 0.004$
 - minimum for slabs & footings of uniform thickness
 - $\frac{A_s}{bh} = 0.002$ grade 40 / 50 bars
 - $= 0.0018$ grade 60 bars

Reinforcement Length

- need length, l_d
 - bond
 - development of yield strength

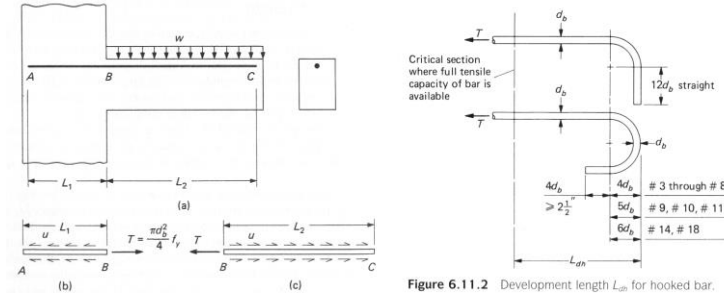
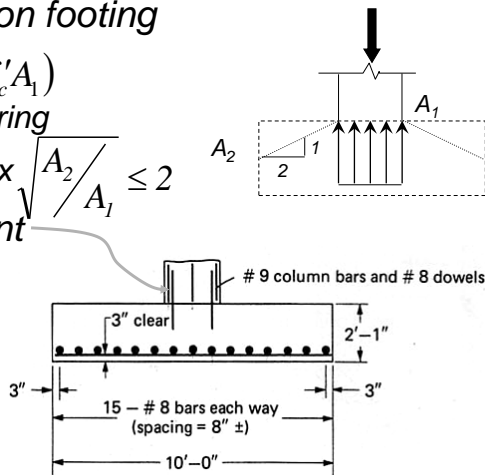

Figure 6.2.1 Development of reinforcement.

Figure 6.11.2 Development length L_{dn} for hooked bar.

Column Connection

- bearing of column on footing
 - $P_u \leq \phi P_n = \phi(0.85 f'_c A_1)$
 - $\phi = 0.65$ for bearing
 - confined: increase x $\sqrt{\frac{A_2}{A_1}} \leq 2$
- dowel reinforcement
 - if $P_u > P_b$, need compression reinforcement
 - min of 4 bars and $0.005A_g$



Wall Footings

- continuous strip for load bearing walls
- plain or reinforced
- behavior
 - wide beam shear
 - bending of projection
- dimensions usually dictated by codes for residential walls
- light loads

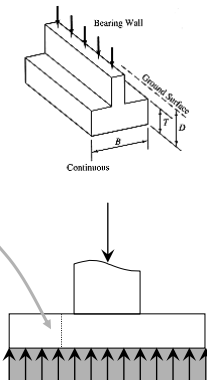

Eccentrically Loaded Footings

- footings subject to moments

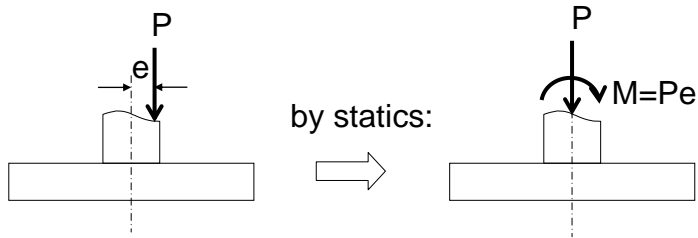

- soil pressure resultant force may not coincide with the centroid of the footing

Kern Limit

- boundary of e for no tensile stress
- triangular stress block with p_{max}

$$volume = \frac{wp_x}{2} = N$$

$$p_{max} = \frac{2N}{wx}$$

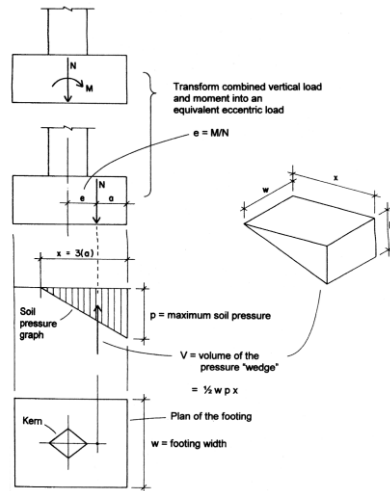

Differential Soil Pressure

- to avoid large rotations, limit the differential soil pressure across footing
- for rigid footing, simplification of soil pressure is a linear distribution based on constant ratio of pressure to settlement

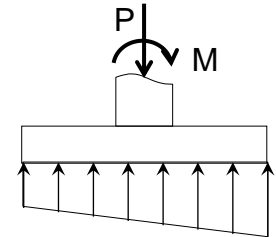

Guidelines

- want resultant of load from pressure inside the middle third of base (kern)
 - ensures stability with respect to overturning

$$SF = \frac{M_{resist}}{M_{overturning}} = \frac{R \cdot x}{M} \geq 1.5$$

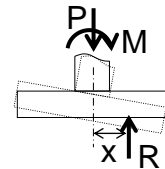

- pressure under toe (maximum) $\leq q_a$
- shortcut using uniform soil pressure for design moments gives similar steel areas

Combined Footings

- supports two columns
- used when space is tight and spread footings would overlap or when at property line



- soil pressure might not be uniform
- proportion so pressure will uniform for sustained loads
- behaves like beam lengthwise

Foundations 29
Lecture 26

Elements of Architectural Structures
ARCH 614

S2007abn

Proportioning

- uniform settling is desired
- area is proportioned with sustained column loads
- want the resultant to coincide with centroid of footing area for uniformly distributed pressure assuming a rigid footing

$$q_{max} \leq q_a$$

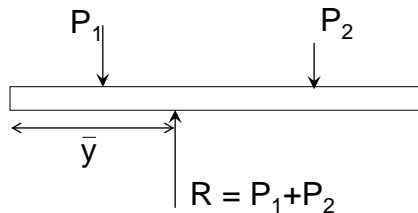

Foundations 31
Lecture 26

Elements of Architectural Structures
ARCH 614

S2007abn

Combined Footing Types

- rectangular
- trapezoid

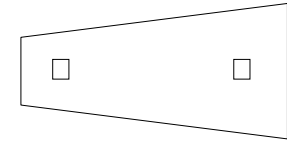

- strap or cantilever
 - prevents overturning of exterior column

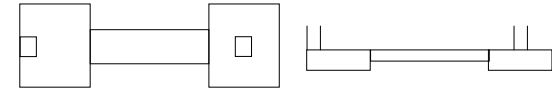

- raft/mat

- more than two columns over an extended area

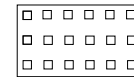

Foundations 30
Lecture 26

Elements of Architectural Structures
ARCH 614

S2007abn

Retaining Walls

- purpose
 - retain soil or other material
- basic parts
 - wall & base
 - additional parts

- counterfort
- buttress
- key

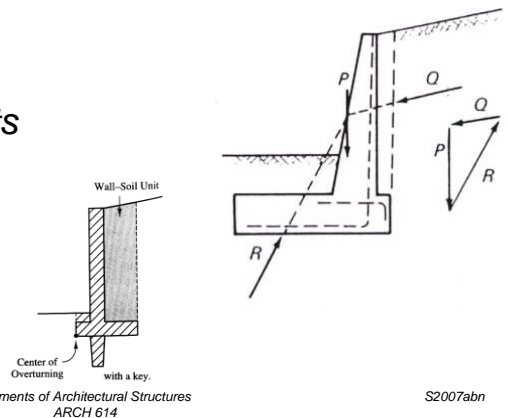

Foundations 32
Lecture 26

Elements of Architectural Structures
ARCH 614

S2007abn

Retaining Walls

- considerations
 - overturning
 - settlement
 - allowable bearing pressure
 - sliding
 - (adequate drainage)

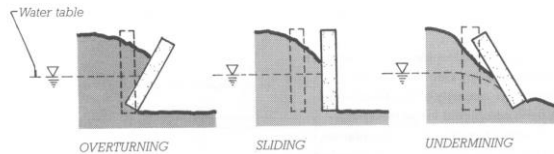
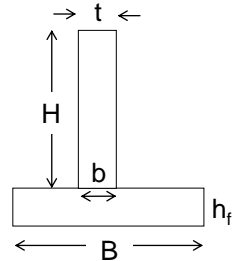

FIGURE 2.50 Three failure mechanisms in retaining walls.

Retaining Wall Proportioning

- estimate size
 - footing size, $B \approx 2/5 - 2/3$ wall height (H)
 - footing thickness $\approx 1/12 - 1/8$ footing size (B)
 - base of stem $\approx 1/10 - 1/12$ wall height ($H+h_f$)
 - top of stem $\geq 12''$



Retaining Walls

- procedure
 - proportion and check stability with working loads for bearing, overturning and sliding
 - design structure with factored loads

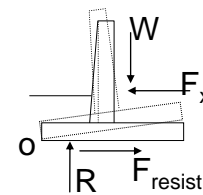

$$SF = \frac{M_{resist}}{M_{overturning}} \geq 1.5 - 2$$

$$SF = \frac{F_{horizontal-resist}}{F_{sliding}} \geq 1.25 - 2$$

Retaining Walls Forces

- design like cantilever beam
 - V_u & M_u for reinforced concrete
 - $V_u \leq \phi V_c$: $\phi = 0.75$ for shear
 - $M_u \leq \phi M_n$: $\phi = 0.9$ for flexure

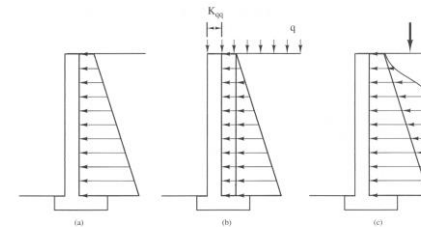
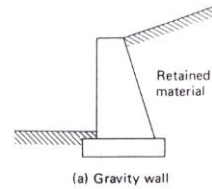

Figure 24.12 Typical loading diagrams for stem design: (a) with no surcharge loads; (b) with uniform surcharge load; (c) with point surcharge load.

Retaining Wall Types

- “gravity” wall
 - usually unreinforced
 - economical & simple



- cantilever retaining wall
 - common

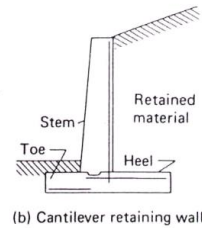

Foundations 37
Lecture 26

Elements of Architectural Structures
ARCH 614

S2007abn

Deep Foundations

- usage
 - when spread footings, mats won't work
 - when they are required to transfer the structural loads to good bearing material
 - to resist uplift or overturning
 - to compact soil
 - to control settlements of spread or mat foundations

Foundations 39
Lecture 26

Elements of Architectural Structures
ARCH 614

S2007abn

Retaining Wall Types

- counterfort wall
 - buttress wall
 - bridge abutment
 - basement frame wall (large basement areas)
- } very tall walls (> 20 - 25 ft)

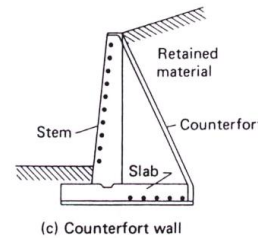

Foundations 38
Lecture 26

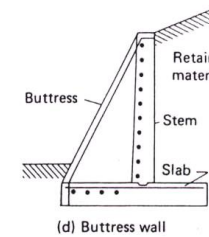

Elements of Architectural Structures
ARCH 614

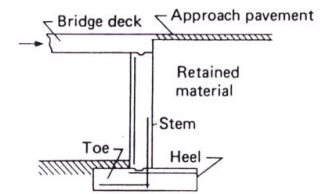

S2007abn

Deep Foundation Types

- piles - usually driven, 6"-8" ϕ , 5' +
 - piers
 - caissons
 - drilled shafts
 - bored piles
 - pressure injected piles
- } drilled, excavated, concreted (with or without steel)
2.5' - 10'/12' ϕ

Foundations 40
Lecture 26

Elements of Architectural Structures
ARCH 614

S2007abn

Deep Foundation Types

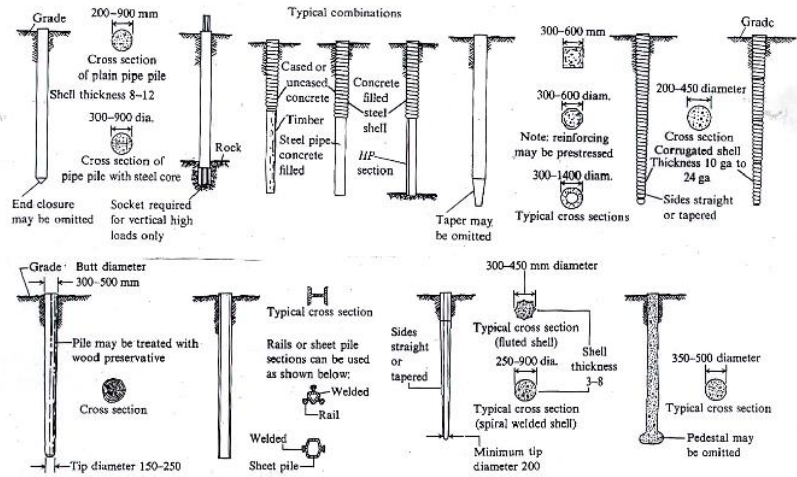

Foundations 41
Lecture 26

Elements of Architectural Structures
ARCH 614

S2007abn

Piles Classified By Material

- **timber**
 - use for temporary construction
 - to densify loose sands
 - embankments
 - fenders, dolphins (marine)
- **concrete**
 - precast: ordinary reinforcement or prestressed
 - designed for axial capacity and bending with handling

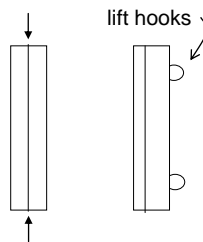

Foundations 43
Lecture 26

Elements of Architectural Structures
ARCH 614

S2007abn

Deep Foundations

- **classification**
 - by material
 - by shape
 - by function (structural, compaction...)
- **pile placement methods**
 - driving with pile hammer (noise & vibration)
 - driving with vibration (quieter)
 - jacking
 - drilling hole & filling with pile or concrete

Foundations 42
Lecture 26

Elements of Architectural Structures
ARCH 614

S2007abn

Piles Classified By Material

- **steel**
 - rolled HP shapes or pipes
 - pipes may be filled with concrete
 - HP displaces little soil and may either break small boulders or displace them to the side

Foundations 44
Lecture 26

Elements of Architectural Structures
ARCH 614

S2007abn

Piles Classified By Function

– end bearing pile (point bearing)

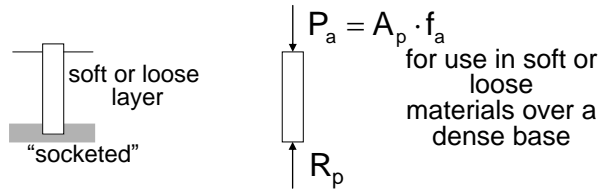

– friction piles (floating)

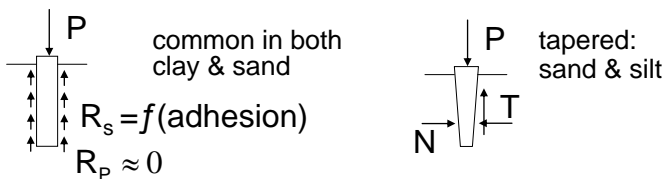

Foundations 45
Lecture 26

Elements of Architectural Structures
ARCH 614

S2007abn

Piles Classified By Function

– combination friction and end bearing

– uplift/tension piles

structures that float,
towers

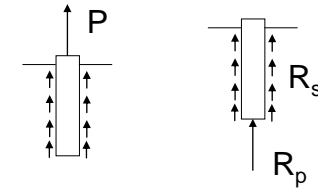

– batter piles

angled,
cost more,
resist large
horizontal loads

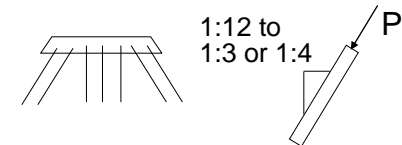

Foundations 46
Lecture 26

Elements of Architectural Structures
ARCH 614

S2007abn

Piles Classified By Function

– fender piles, dolphins, pile clusters

large # of piles
in a small area

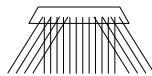

– compaction piles

- used to densify loose sands

– drilled piers

- eliminate need for pile caps
- designed for bearing capacity (not slender)

Foundations 47
Lecture 26

Elements of Architectural Structures
ARCH 614

S2007abn

Pile Caps and Grade Beams

– like multiple column footing

– more shear areas to consider

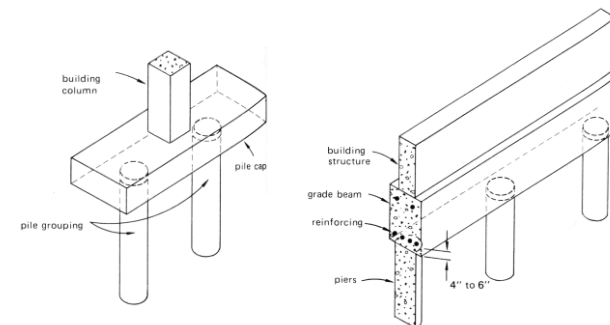

Foundations 48
Lecture 26

Elements of Architectural Structures
ARCH 614

S2007abn