

lecture
five



moments and rigid body equilibrium

Moments 1
Lecture 5

Elements of Architectural Structures
ARCH 614

S2009abn

Moments

- forces have the tendency to make a body rotate about an axis

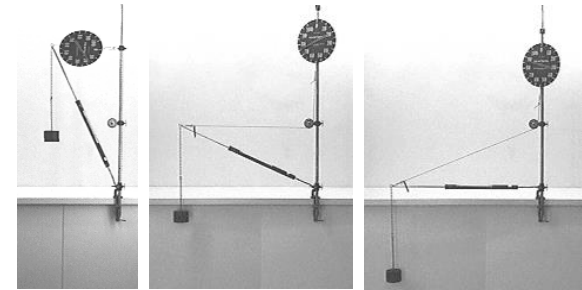

<http://www.physics.umd.edu>

– same translation but different rotation

Moments 6
Lecture 4

Elements of Architectural Structures
ARCH 614

S2005abn

Moments

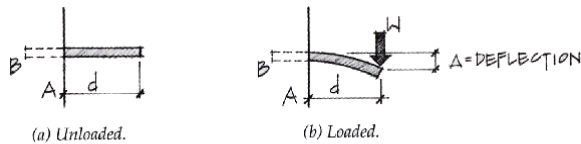

Figure 2.33 Moment on a cantilever beam.

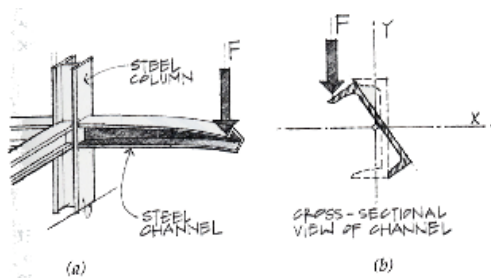

Figure 2.34 An example of torsion on a cantilever beam.

Moments 7

Elements of Architectural Structures
ARCH 614

S2004abn

Moments

- a force acting at a different point causes a different moment:

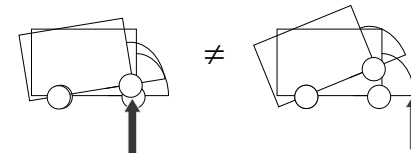

Moments 8

Elements of Architectural Structures
ARCH 614

S2004abn

Moments

- defined by magnitude and direction
- units: N·m, k·ft
- direction:
 - + CW (!)
 - CCW
- value found from F and \perp distance

$$M = F \cdot d$$
- d also called “lever” or “moment” arm

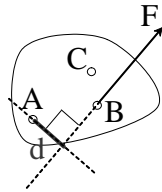

Moments 9
Lecture 4

Elements of Architectural Structures
ARCH 614

S2005abn

Moments

- with same F :

$$M_A = F \cdot d_1 < M_A = F \cdot d_2 \quad (\text{bigger})$$

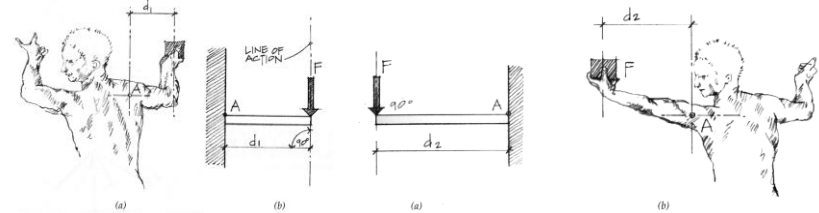

Moments 10
Lecture 4

Elements of Architectural Structures
ARCH 614

S2005abn

Moments

- additive with sign convention
- can still move the force along the line of action
- location of moment independent

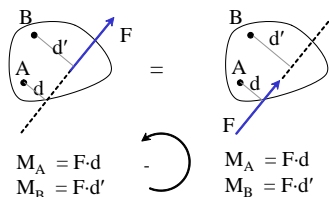

Moments 11

Elements of Architectural Structures
ARCH 614

S2004abn

Moments

- Varignon's Theorem
 - resolve a force into components at a point and finding perpendicular distances
 - calculate sum of moments
 - equivalent to original moment
- makes life easier!
 - geometry
 - when component runs through point, $d=0$

Moments 12

Elements of Architectural Structures
ARCH 614

S2004abn

Moments of a Force

- moments of a force
 - introduced in Physics as “Torque Acting on a Particle”
 - and used to satisfy rotational equilibrium

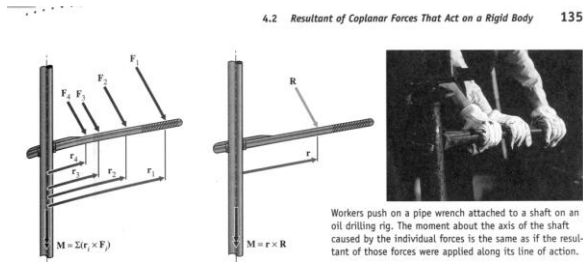

Moments 9
Lecture 4

Elements of Architectural Structures
ARCH 614

S2006abn

Physics and Moments of a Force

- my Physics book (right hand rule):

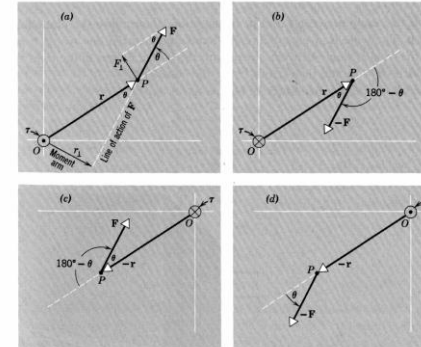

FIGURE 11-2 The plane shown is that defined by r and F in Fig. 11-1. (a) The magnitude of τ is given by $F r_{\perp}$ (Eq. 11-2b) or by $r F_{\perp}$ (Eq. 11-2c). (b) Reversing F reverses the direction of τ . (c) Reversing r reverses the direction of τ . (d) Reversing F and r leaves the direction of τ unchanged. The directions of τ are represented by \odot (perpendicularly out of the figure, the symbol representing the tip of an arrow) and by \otimes (perpendicularly into the figure, the symbol representing the tail of an arrow).

Moments 10
Lecture 4

Elements of Architectural Structures
ARCH 614

S2006abn

Moment Couples

- 2 forces
 - same size
 - opposite direction
 - distance d apart
 - cw or ccw

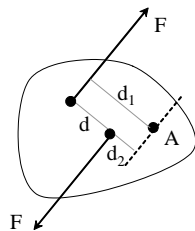

$$M = F \cdot d$$

- not dependant on point of application

$$M = F \cdot d_1 - F \cdot d_2$$

TOPIC 13

Elements of Architectural Structures
ARCH 614

S2004abn

Moment Couples

- equivalent couples
 - same magnitude and direction
 - F & d may be different

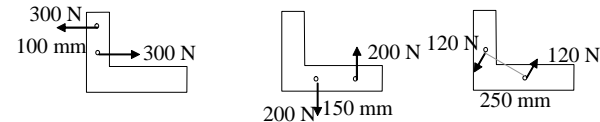

Moments 14

Elements of Architectural Structures
ARCH 614

S2004abn

Moment Couples

- added just like moments caused by one force
- can replace two couples with a single couple

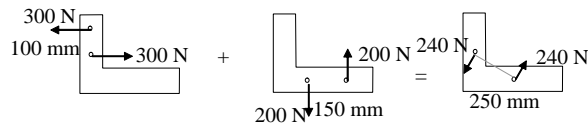

Moments 15

Elements of Architectural Structures
ARCH 614

S2004abn

Equivalent Force Systems

- two forces at a point is equivalent to the resultant at a point
- resultant is equivalent to two components at a point
- resultant of equal & opposite forces at a point is zero
- put equal & opposite forces at a point (sum to 0)
- transmission of a force along action line

Moments 16
Lecture 4

Elements of Architectural Structures
ARCH 614

S2005abn

Moment Couples

- moment couples in structures

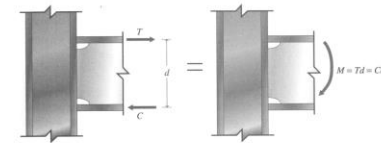

The flanges of a steel beam are welded to the flange of a column. Equal and opposite forces F and C in the beam flanges form a couple with moment M that is transferred into the column.

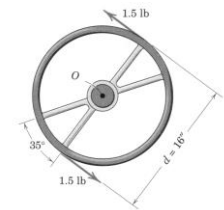

Moments 14
Lecture 4

Elements of Architectural Structures
ARCH 614

S2006abn

Force-Moment Systems

- single force causing a moment can be replaced by the same force at a different point by providing the moment that force caused

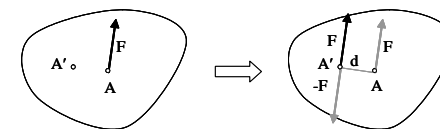

- moments are shown as arched arrows



Moments 16

Elements of Architectural Structures
ARCH 614

S2004abn

Force-Moment Systems

- a force-moment pair can be replaced by a force at another point causing the original moment

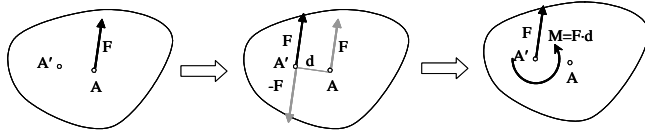

Moments 17

Elements of Architectural Structures
ARCH 614

S2004abn

Parallel Force Systems

- forces are in the same direction
- can find resultant force
- need to find location for equivalent moments

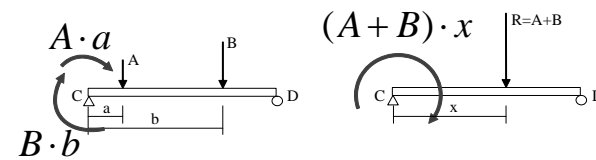

Moments 18

Elements of Architectural Structures
ARCH 614

S2004abn

Equilibrium

- rigid body
 - doesn't deform
 - coplanar force systems

- static:

$$R_x = \sum F_x = 0 \quad (\Sigma H)$$

$$R_y = \sum F_y = 0 \quad (\Sigma V)$$

$$M = \sum M = 0$$

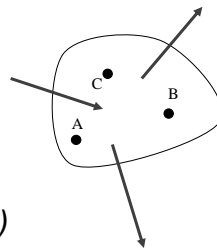

Equilibrium 3
Lecture 5

Elements of Architectural Structures
ARCH 614

S2006abn

Free Body Diagram

- FBD (sketch)
- tool to see all forces on a body or a point including
 - external forces
 - weights
 - force reactions
 - external moments
 - moment reactions
 - internal forces

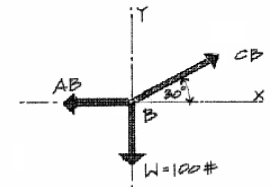

Equilibrium 10

Elements of Architectural Structures
ARCH 614

S2004abn

Free Body Diagram

- determine body
- FREE it from:
 - ground
 - supports & connections
- draw all external forces acting ON the body
 - reactions
 - applied forces
 - gravity

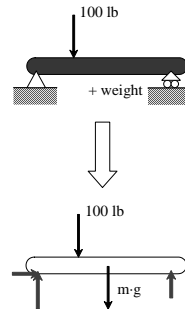

Equilibrium 11

Elements of Architectural Structures
ARCH 614

S2004abn

Free Body Diagram

- solve equations
 - most times 1 unknown easily solved
 - plug into other equation(s)
- common to have unknowns of
 - force magnitudes
 - force angles
 - moment magnitudes

Equilibrium 10
Lecture 5

Elements of Architectural Structures
ARCH 614

S2006abn

Free Body Diagram

- sketch FBD with relevant geometry
- resolve each force into components
 - known & unknown angles – name them
 - known & unknown forces – name them
 - known & unknown moments – name them
- are any forces related to other forces?
- for the unknowns
- write only as many equilibrium equations as needed
- solve up to 3 equations

Equilibrium 12

Elements of Architectural Structures
ARCH 614

S2004abn

Reactions on Rigid Bodies

- result of applying force
- unknown size
- connection or support type
 - known direction
 - related to motion prevented

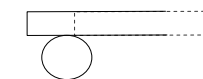

no vertical motion

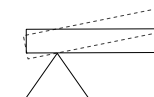

no translation

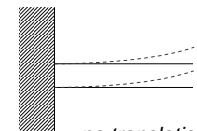

no translation
no rotation

Equilibrium 19

Elements of Architectural Structures
ARCH 614

S2004abn

Supports and Connections

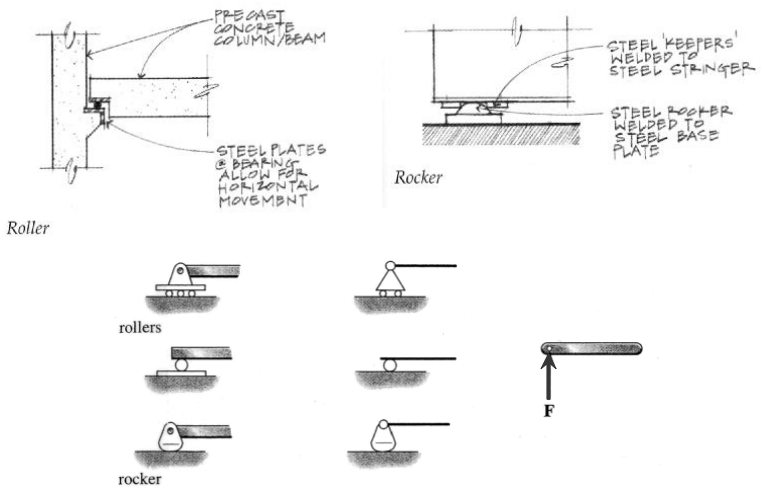

Equilibrium 20 Elements of Architectural Structures ARCH 614 S2004abn

Supports and Connections

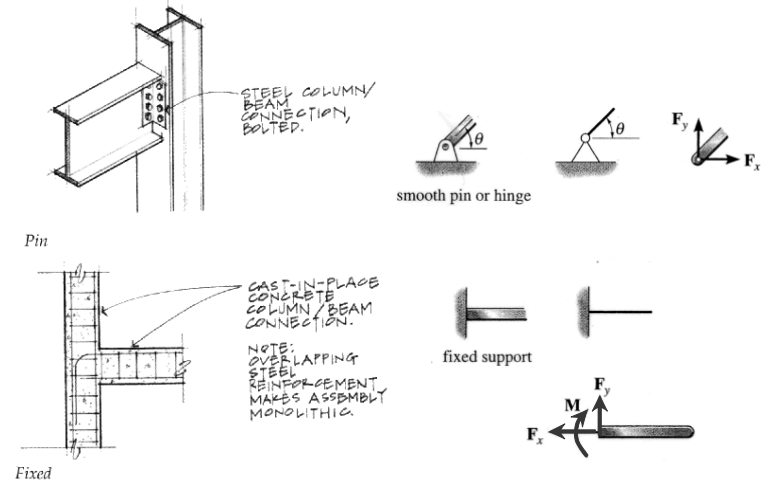

Equilibrium 21 Elements of Architectural Structures ARCH 614 S2004abn

Moment Equations

- sum moments at intersection where the most forces intersect
- multiple moment equations may not be useful
- combos:

$$\begin{matrix} \sum F_x = 0 & \sum F = 0 & \sum M_1 = 0 \\ \sum F_y = 0 & \sum M_1 = 0 & \sum M_2 = 0 \\ \sum M_1 = 0 & \sum M_2 = 0 & \sum M_3 = 0 \end{matrix}$$

Equilibrium 21 Lecture 5 Elements of Architectural Structures ARCH 614 S2005abn

Concentrated Loads

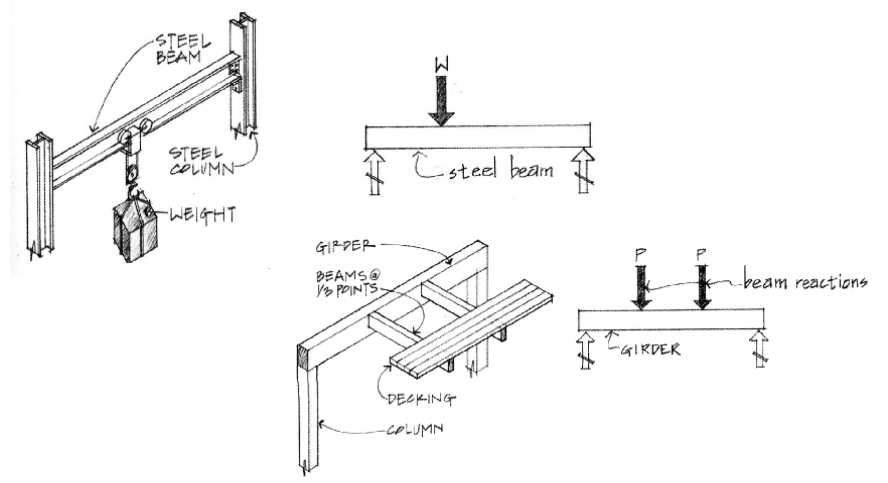

Loads 15 Elements of Architectural Structures ARCH 614 S2004abn

Distributed Loads

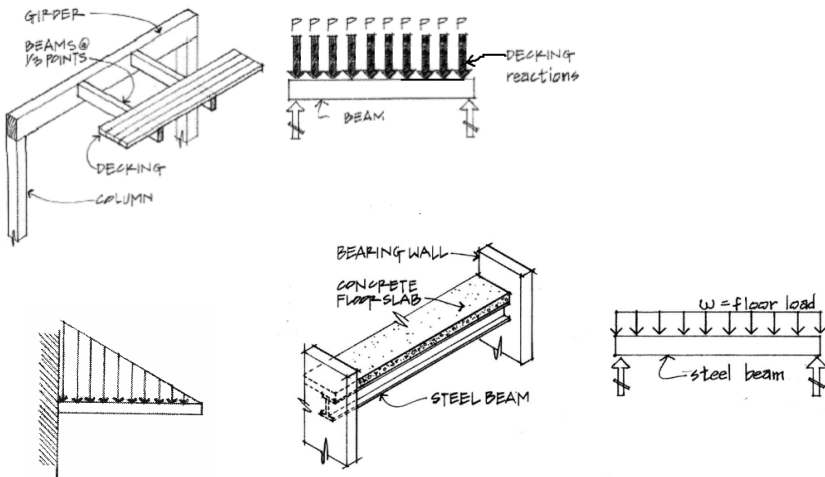

Loads 16

Elements of Architectural Structures
ARCH 614

S2004abn

Equivalent Force Systems

- replace forces by resultant
- place resultant where $M = 0$
- using calculus and area centroids

$$W = \int_0^L w dx = \int dA_{\text{loading}} = A_{\text{loading}}$$

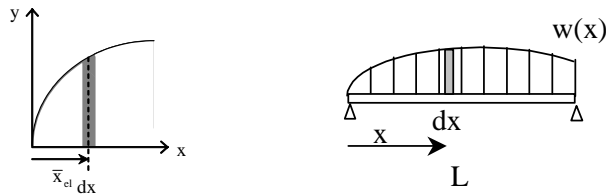

Loads 17
Lecture 9

Elements of Architectural Structures
ARCH 614

S2006abn

Beam Supports

- *statically determinate*

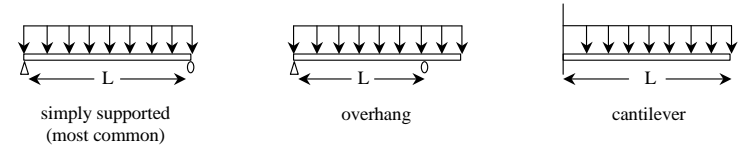

- *statically indeterminate*

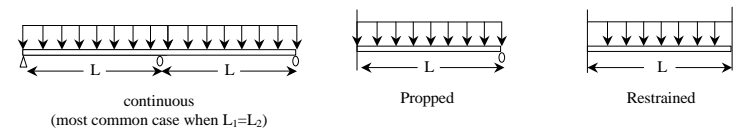

Internal Beam Forces 20
Lecture 12

Elements of Architectural Structures
ARCH 614

S2004abn

Load Areas

- area is width \times "height" of load
- w is load per unit length
- W is total load

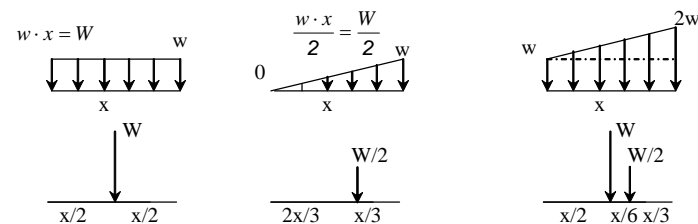

Loads 19
Lecture 9

Elements of Architectural Structures
ARCH 614

S2006abn

Method of Sections

- relies on internal forces being in equilibrium on a section
- cut to expose 3 or less members
- coplanar forces $\rightarrow \sum M = 0$ too

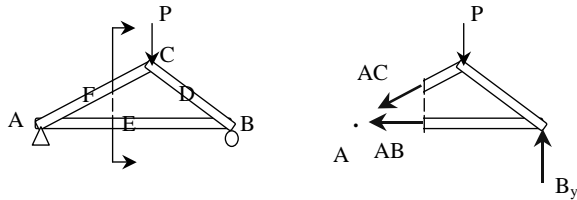

Steel Trusses 15
Lecture 17

Elements of Architectural Structures
ARCH 614

S2007abn

Method of Sections

- joints on or off the section are good to sum moments
- quick for few members
- not always obvious where to cut or sum

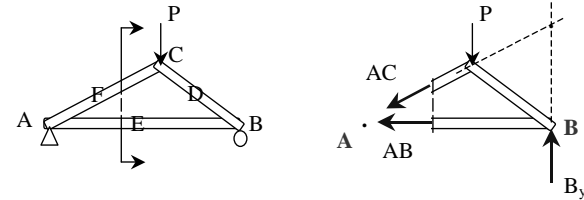

Steel Trusses 16
Lecture 17

Elements of Architectural Structures
ARCH 614

S2007abn